

 Acque pulite

 Uso domestico

 Uso civile



UTILIZZI E INSTALLAZIONI

VSP è una unità di pompaggio in grado di coprire un'ampia varietà di applicazioni. In ambito residenziale e commerciale è idoneo per l'approvvigionamento idrico e l'aumento di pressione.

VSP si adatta ad ogni tipologia di impianto di pressurizzazione, anche esistente, garantendo il massimo comfort e consentendo un notevole risparmio energetico.

DESCRIZIONE DEL PRODOTTO

VSP è un sistema composto da un'elettropompa e da un variatore di frequenza integrato che, corredato di sensore di pressione, garantisce una pressione costante al variare della quantità d'acqua richiesta dall'impianto.

VSP è un prodotto pronto all'uso, che non prevede nessuna procedura di configurazione. Tramite il pannello di controllo, l'utente può modificare la pressione di lavoro e visualizzare i parametri di funzionamento e i messaggi di allarme.

Per gli utenti più esperti è possibile entrare nel menù avanzato per poter modificarne i parametri di fabbrica, mediante una procedura guidata, e adeguare l'unità a particolari situazioni impiantistiche.

VSP è una unità di pompaggio intelligente, dotata di:

- ✳ **display e tastiera** che permettono una semplice ed intuitiva configurazione e lettura dei parametri di funzionamento;
- ✳ porte di interfaccia per **segnali analogici e digitali** aggiuntivi in ingresso e uscita;
- ✳ **tecnologia PFC** che consente di mantenere invariate le prestazioni idrauliche al variare delle tensioni di alimentazione fino ad un $\pm 20\%$ rispetto al valore nominale;

- ✳ **comunicazione RS 485** per il collegamento a un secondo dispositivo in parallelo.

Protezione integrata contro:

- ✳ marcia a secco
- ✳ sovracorrente
- ✳ sovratensione e sottotensione
- ✳ sovratemperatura
- ✳ corto circuito
- ✳ mancanza di fasi nei collegamenti (per versione trifase)

DATI TECNICI

- Tensione di alimentazione:
 - 1~ 230V $\pm 10\%$ oppure 3~ 400V $\pm 10\%$
 - Frequenza: **50/60 Hz**
- Fare riferimento ai dati tecnici delle specifiche elettropompe per temperatura del liquido, temperatura ambiente e grado di protezione.

VANTAGGI PER L'UTILIZZATORE

- ✳ Facilità di installazione, configurazione e regolazione
- ✳ Maggiore comfort, grazie all'ottimizzazione delle prestazioni e alla bassa rumorosità
- ✳ Risparmio energetico riduce le correnti di spunto e di funzionamento garantendo
- ✳ Compensazione automatica della fluttuazione della tensione di alimentazione
- ✳ Comunicazione con un altro dispositivo per aumentare le capacità del sistema
- ✳ Gestione intelligente di controllo ed intervento in caso di anomalie

PANNELLO DI CONTROLLO

Permette di accedere e navigare tra i menù di configurazione, variare i parametri di funzionamento, attivare o arrestare l'unità di pompaggio.

1. Tasti frecce di scorrimento (▼) (▲)
2. Tasto uscita menù ESC (ESC)
3. Tasto accensione/spengimento ON/OFF (⏻)
4. Tasto conferma OK (OK)
5. Display a 4 retroilluminazioni per indicare lo stato di funzionamento del VSP

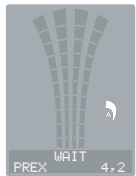

Display BIANCO
(ATTESA)



Display VERDE
(MARCIA)



Display ROSSO
(ERRORE)



Display GIALLO
(MENÙ DI
PROGRAMMAZIONE)

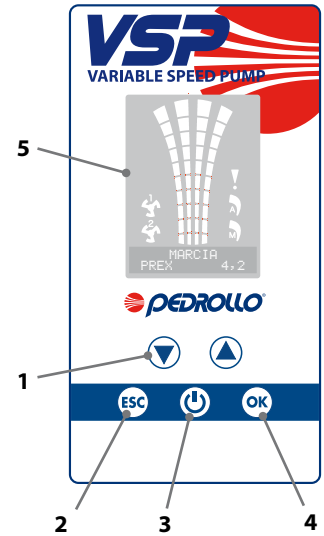

SIMBOLOGIA DISPLAY

6. Spia segnalazione ALLARME !
7. Spia funzionamento AUTOMATICO (A)
8. Spia funzionamento MANUALE (M)
9. Spia elettropompa n.1 in funzione (P1)
10. Spia elettropompa n.2 in funzione (P2) (se presente)
11. Spia segnalazione WI-FI attivo (Wi-Fi) (se presente)
12. Display alfanumerico a 2 righe per la visualizzazione di: tensione, frequenza, corrente, cosφ, pressione, livello, stato di funzionamento impianto, anomalie impianto.
13. Spie led stato di funzionamento del VSP

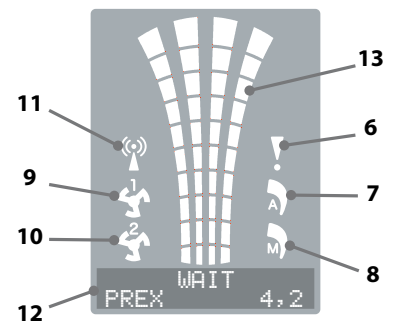

INSTALLAZIONE TIPICA

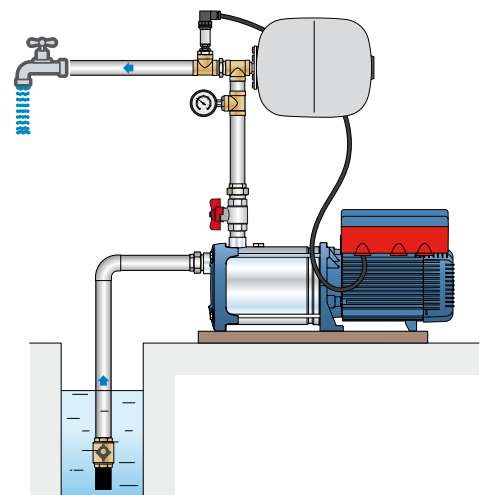
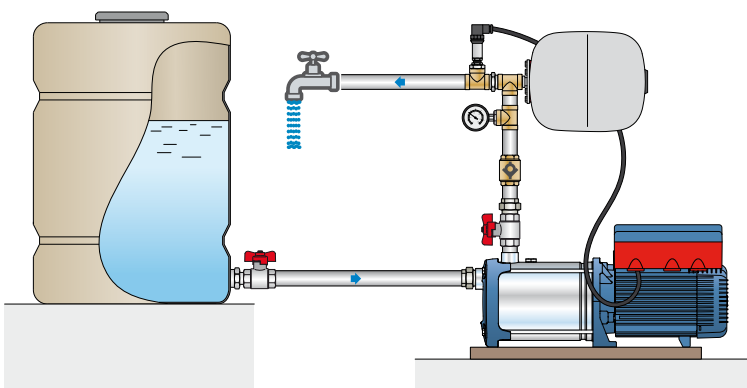

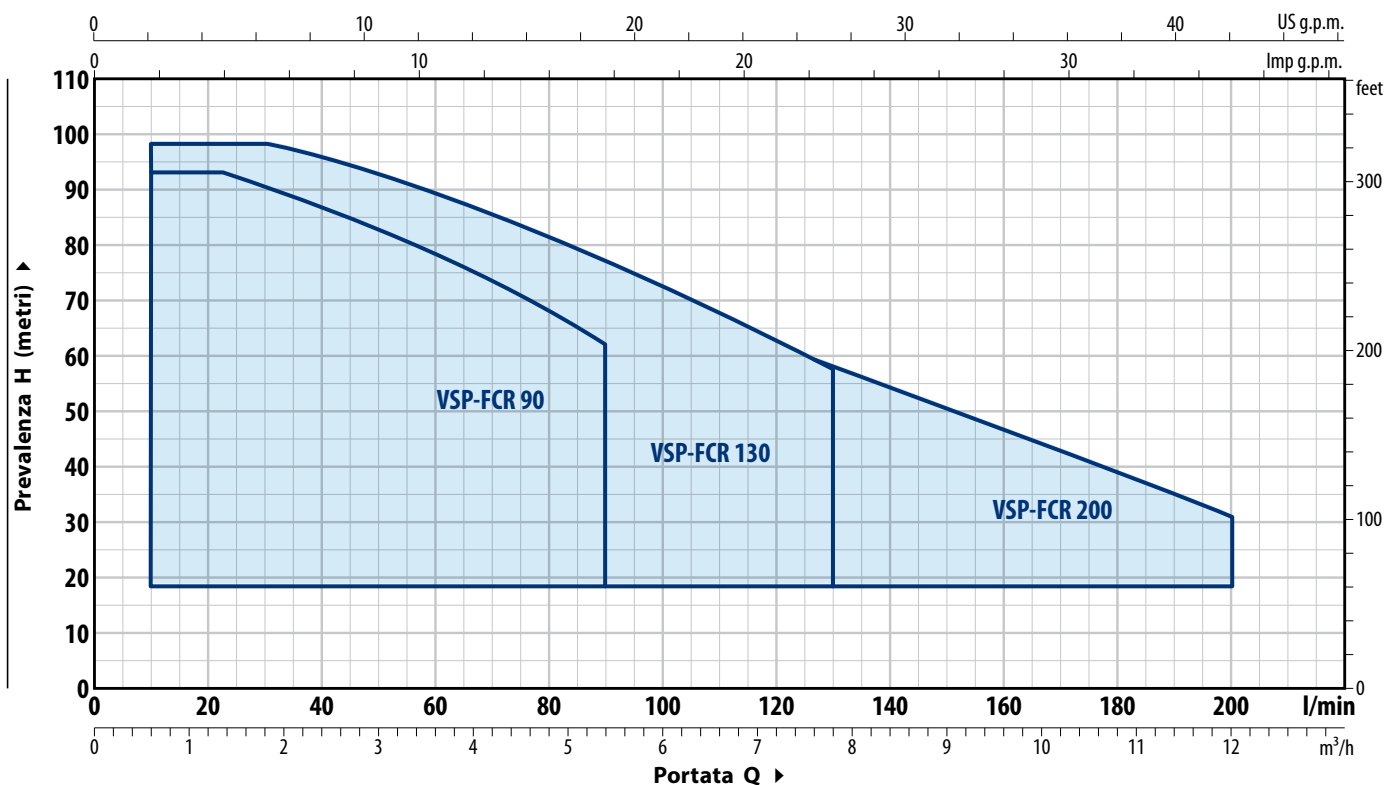

DATI TECNICI

TIPO	POTENZA P ₂		ASSORBIMENTI 230 V	PRESTAZIONI MAX		PRESTAZIONI (SET POINT REGOLABILE)					
	kW	HP		Q litri/min	H metri	Set Point Min		Set Point Taratura Std		Set Point Max	
Monofase						bar	l/min	bar	l/min	bar	l/min
VSPm - FCR 75/90	1.5	2	9.8 A	5 – 90	71.5 – 43.5	1.9	5 – 60	4.0	5 – 86	7.0	5 – 16
VSPm - FCR 80/130	1.5	2	9.8 A	5 – 130	74.5 – 30	2.0	5 – 107	4.0	5 – 107	7.3	5 – 22
VSPm - FCR 70/200	1.5	2	9.8 A	5 – 200	65.5 – 21	1.8	5 – 180	4.0	5 – 115	6.4	5 – 36

TIPO	POTENZA P ₂		ASSORBIMENTI 400 V	PRESTAZIONI MAX		PRESTAZIONI (SET POINT REGOLABILE)					
	kW	HP		Q litri/min	H metri	Set Point Min		Set Point Taratura Std		Set Point Max	
Trifase						bar	l/min	bar	l/min	bar	l/min
VSP - FCR 75/90	1.5	2	3.6 A	5 – 90	71.5 – 43.5	1.9	5 – 60	4.0	5 – 86	7.0	5 – 16
VSP - FCR 100/90	2.2	3	4.9 A	5 – 90	94 – 62.5	2.5	5 – 58	4.0	5 – 71	9.2	5 – 20
VSP - FCR 80/130	1.5	2	3.6 A	5 – 130	74.5 – 30	2.0	5 – 107	4.0	5 – 107	7.3	5 – 22
VSP - FCR 105/130	2.2	3	4.9 A	5 – 130	98 – 57.5	2.7	5 – 90	4.0	5 – 107	9.6	5 – 30
VSP - FCR 70/200	1.5	2	3.6 A	5 – 200	65.5 – 21	1.8	5 – 180	4.0	5 – 115	6.4	5 – 36
VSP - FCR 95/200	2.2	3	4.9 A	5 – 200	87.5 – 42	2.4	5 – 178	4.0	5 – 175	8.6	5 – 32

CURVE DI PRESTAZIONE

50 Hz

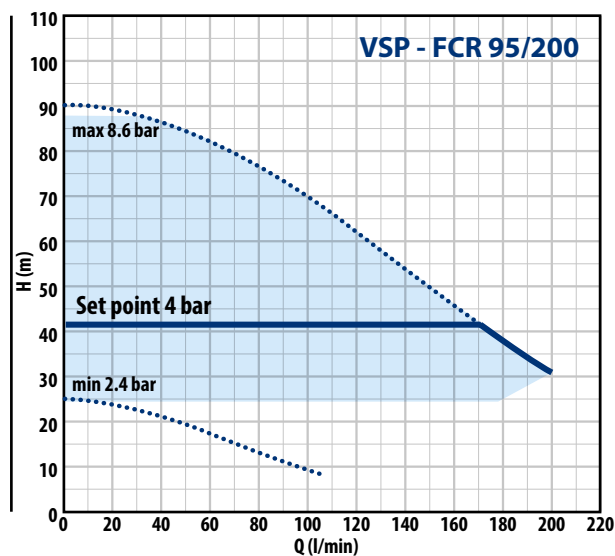
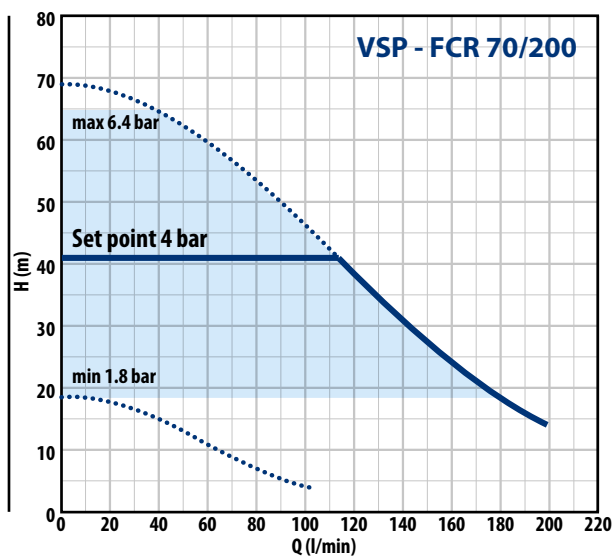
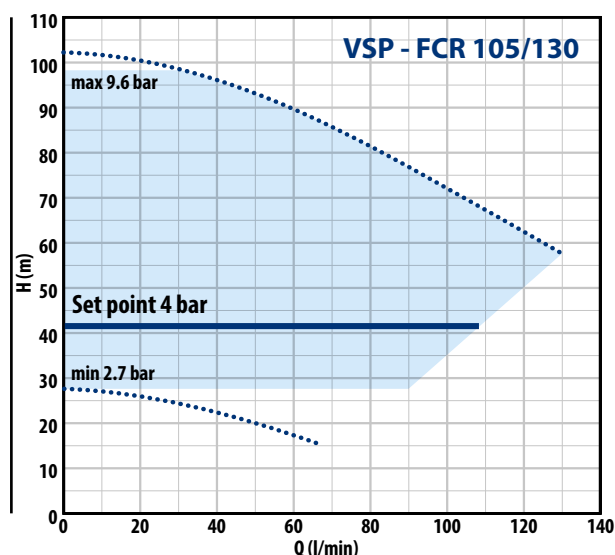
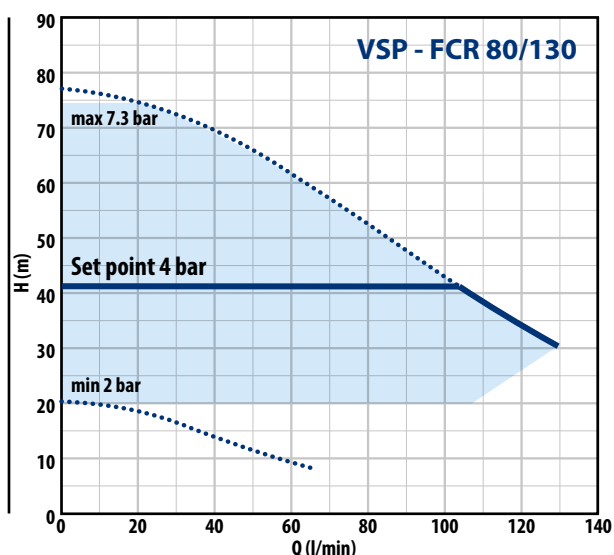
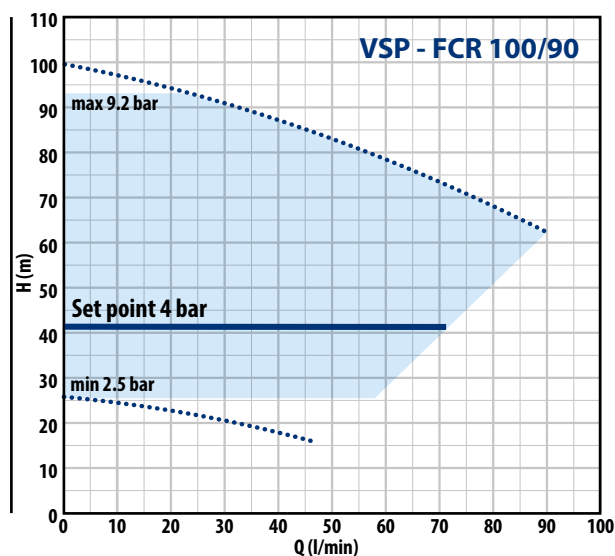
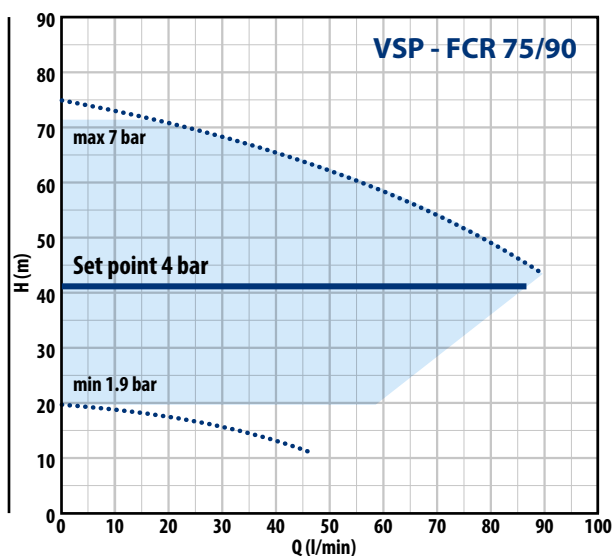

VSP - FCR

DIMENSIONI E PESI

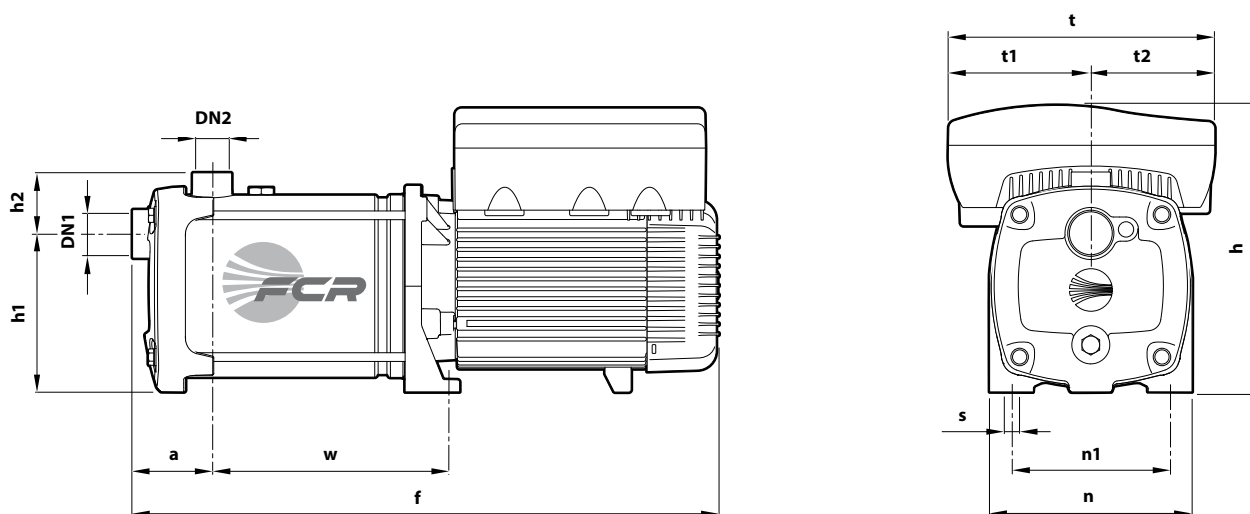

TIPO		BOCCHIE		DIMENSIONI mm												kg	
Monofase	Trifase	DN1	DN2	f	a	w	h	h1	h2	t	t1	t2	n	n1	s	1~	3~
VSPm - FCR 75/90	VSP - FCR 75/90	1 1/4"	1"	445	75	139	260	145	59	242	129	113	185	145	11	21.7	21.7
-	VSP - FCR 100/90			471		165										-	21.9
VSPm - FCR 80/130	VSP - FCR 80/130			445		139										21.9	21.9
-	VSP - FCR 105/130			471		165										-	21.9
VSPm - FCR 70/200	VSP - FCR 70/200			445		139										24.1	23.9
-	VSP - FCR 95/200			471		165										-	24.0

CAMPO DI PRESTAZIONE

50 Hz

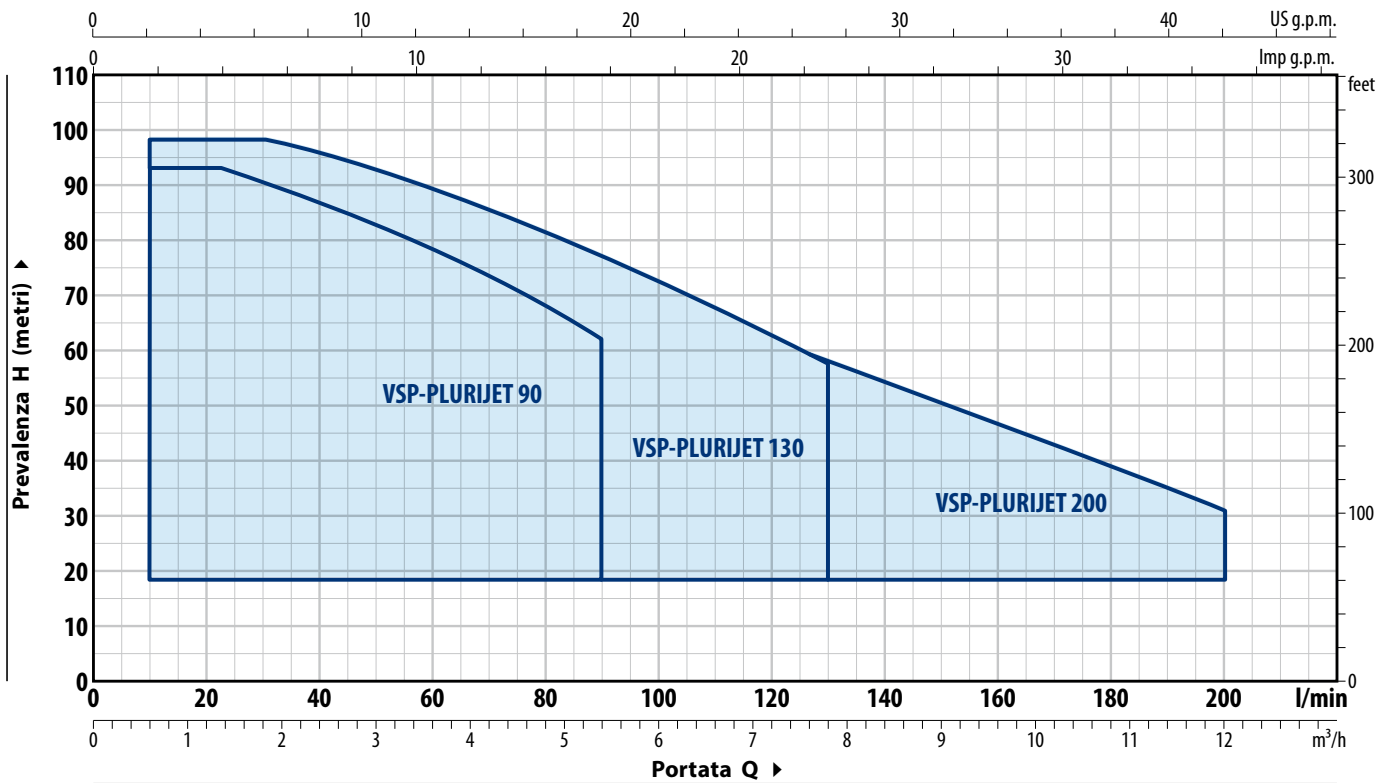

DATI TECNICI

TIPO	POTENZA		ASSORBIMENTI	PRESTAZIONI MAX		PRESTAZIONI (SET POINT REGOLABILE)					
	P ₂			Q	H	Set Point Min		Set Point Taratura Std		Set Point Max	
Monofase	kW	HP	230 V			litri/min	metri	bar	l/min	bar	l/min
VSPm - PLURIJET 75/90	1.5	2	9.8 A	5 - 90	71.5 - 43.5	1.9	5 - 60	4.0	5 - 86	7.0	5 - 16
VSPm - PLURIJET 80/130	1.5	2	9.8 A	5 - 130	74.5 - 30	2.0	5 - 107	4.0	5 - 107	7.3	5 - 22
VSPm - PLURIJET 70/200	1.5	2	9.8 A	5 - 200	65.5 - 21	1.8	5 - 180	4.0	5 - 115	6.4	5 - 36

TIPO	POTENZA		ASSORBIMENTI	PRESTAZIONI MAX		PRESTAZIONI (SET POINT REGOLABILE)					
	P ₂			Q	H	Set Point Min		Set Point Taratura Std		Set Point Max	
Trifase	kW	HP	400 V			litri/min	metri	bar	l/min	bar	l/min
VSP - PLURIJET 75/90	1.5	2	3.6 A	5 - 90	71.5 - 43.5	1.9	5 - 60	4.0	5 - 86	7.0	5 - 16
VSP - PLURIJET 100/90	2.2	3	4.9 A	5 - 90	94 - 62.5	2.5	5 - 58	4.0	5 - 71	9.2	5 - 20
VSP - PLURIJET 80/130	1.5	2	3.6 A	5 - 130	74.5 - 30	2.0	5 - 107	4.0	5 - 107	7.3	5 - 22
VSP - PLURIJET 105/130	2.2	3	4.9 A	5 - 130	98 - 57.5	2.7	5 - 90	4.0	5 - 107	9.6	5 - 30
VSP - PLURIJET 70/200	1.5	2	3.6 A	5 - 200	65.5 - 21	1.8	5 - 180	4.0	5 - 115	6.4	5 - 36
VSP - PLURIJET 95/200	2.2	3	4.9 A	5 - 200	87.5 - 42	2.4	5 - 178	4.0	5 - 175	8.6	5 - 32

VSP - PLURIJET

CURVE DI PRESTAZIONE

50 Hz

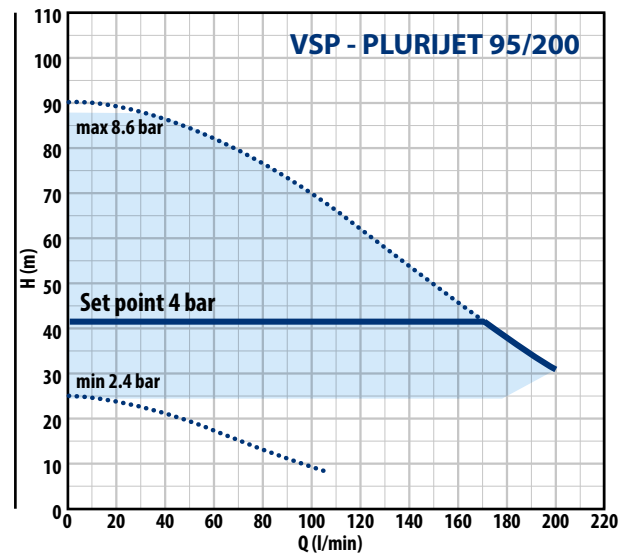
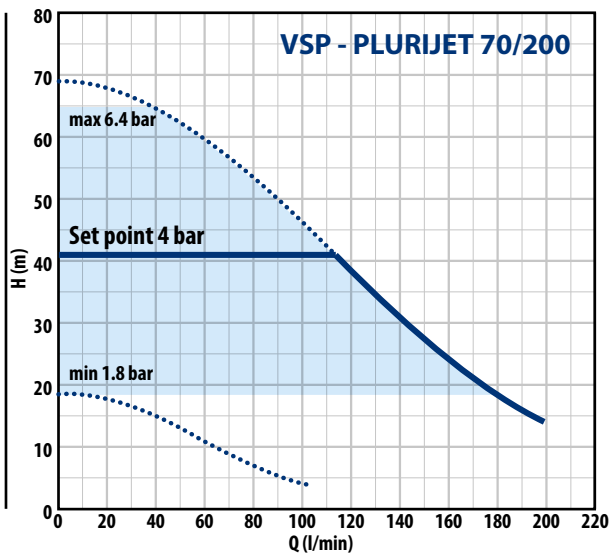
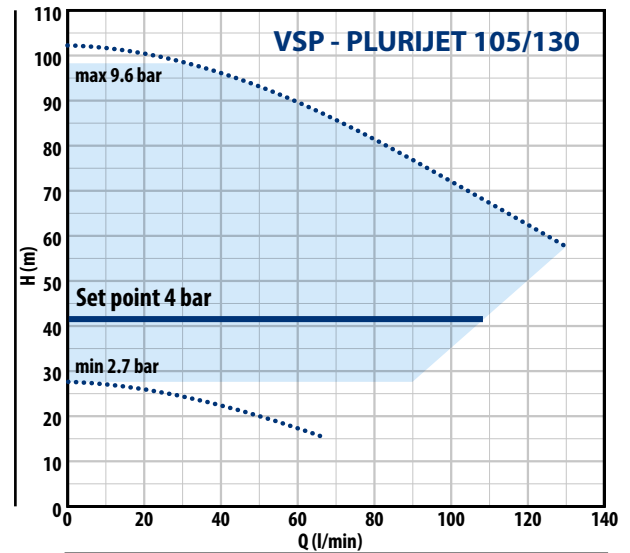
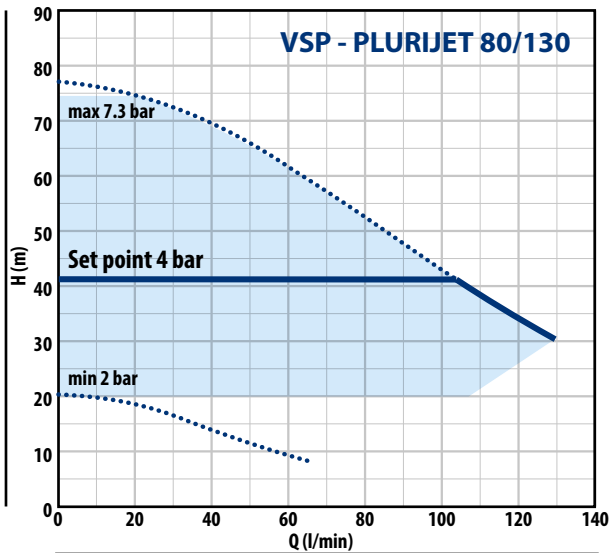
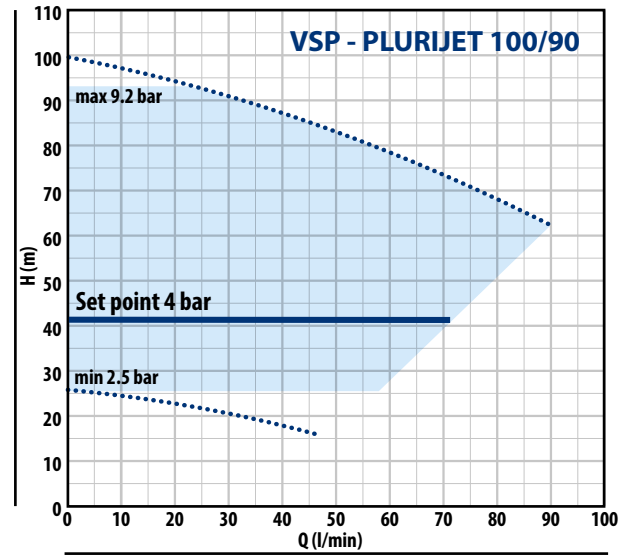
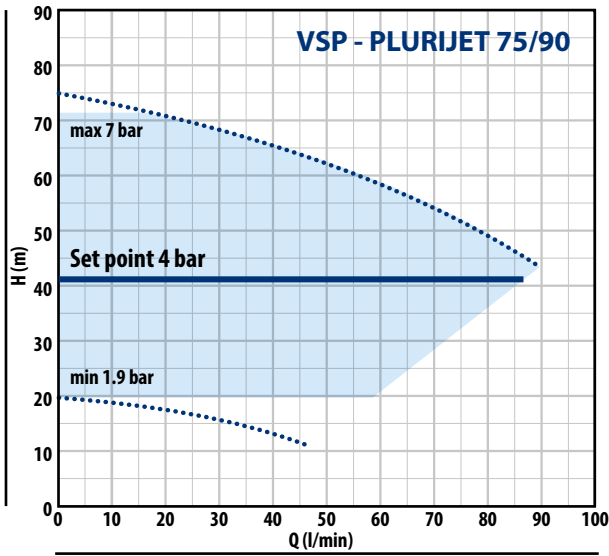

DIMENSIONI E PESI

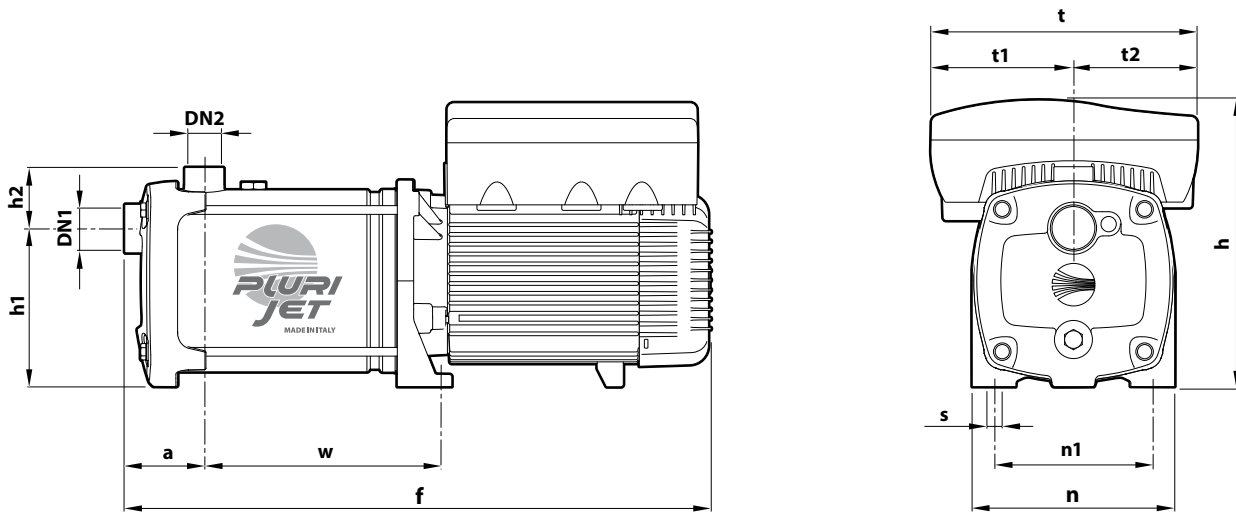

TIPO		BOCCHIE		DIMENSIONI mm													kg		
Monofase	Trifase	DN1	DN2	f	a	w	h	h1	h2	t	t1	t2	n	n1	s	1~	3~		
VSPm - PLURIJET 75/90	VSP - PLURIJET 75/90	1 1/4"	1"	497		191										21.7	21.7		
-	VSP - PLURIJET 100/90			523		217											-	23.9	
VSPm - PLURIJET 80/130	VSP - PLURIJET 80/130			497		191												21.9	21.9
-	VSP - PLURIJET 105/130			523		217	75		260	145	59	242	129	113	185	145	11	-	24.1
VSPm - PLURIJET 70/200	VSP - PLURIJET 70/200			497		191												21.9	21.9
-	VSP - PLURIJET 95/200			523		217												-	24.0

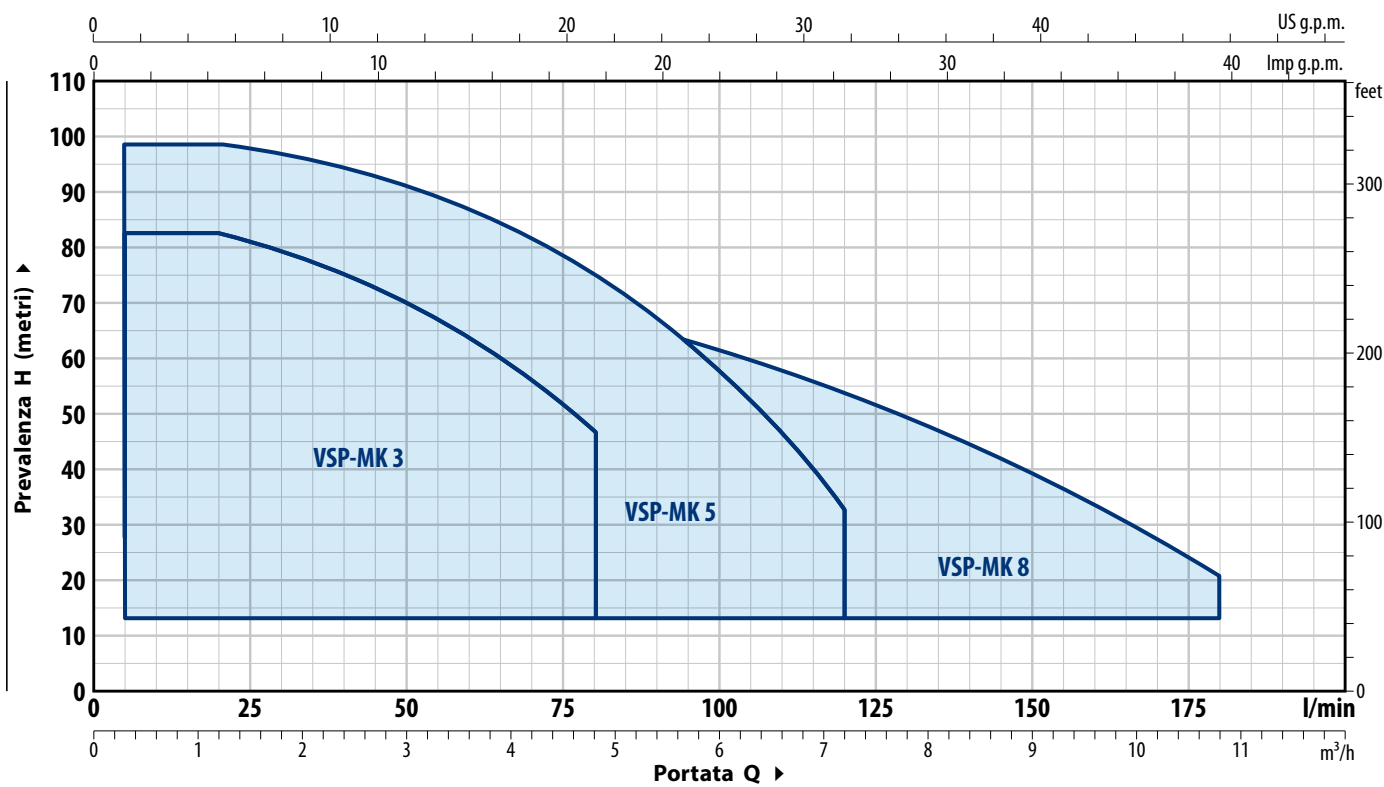

DATI TECNICI

TIPO	POTENZA P ₂		ASSORBIMENTI 230 V	PRESTAZIONI MAX		PRESTAZIONI (SET POINT REGOLABILE)					
	kW	HP		Q litri/min	H metri	Set Point Min		Set Point Taratura Std		Set Point Max	
Monofase						bar	l/min	bar	l/min	bar	l/min
VSPm - MK 3/3	0.75	1	6.2 A	10 - 80	52 - 29	1.4	5 - 52	4.0	5 - 52	5.0	5 - 14
VSPm - MK 3/5	1.1	1.5	7.8 A	10 - 80	85 - 48	2.3	5 - 52	4.0	5 - 72	8.3	5 - 13
VSPm - MK 3/6	1.5	2	9.0 A	10 - 80	101 - 56	2.7	5 - 53	4.0	5 - 65	9.7	5 - 19
VSPm - MK 5/4	0.75	1	6.4 A	20 - 120	55 - 20	1.5	5 - 101	4.0	5 - 82	5.3	5 - 26
VSPm - MK 5/5	1.1	1.5	6.5 A	20 - 120	69 - 21.5	1.8	5 - 108	4.0	5 - 99	6.7	5 - 13
VSPm - MK 5/7	1.5	2	9.0 A	20 - 120	95 - 30	2.6	5 - 109	4.0	5 - 111	9.3	5 - 16
VSPm - MK 8/4	1.1	1.5	8.3 A	40 - 180	53 - 12	1.4	5 - 175	4.0	5 - 115	5.2	5 - 30
VSPm - MK 8/5	1.5	2	10.0 A	40 - 180	68 - 15.5	1.8	5 - 175	4.0	5 - 138	6.6	5 - 45

TIPO	POTENZA P ₂		ASSORBIMENTI 400 V	PRESTAZIONI MAX		PRESTAZIONI (SET POINT REGOLABILE)					
	kW	HP		Q litri/min	H metri	Set Point Min		Set Point Taratura Std		Set Point Max	
Trifase						bar	l/min	bar	l/min	bar	l/min
VSP - MK 3/3	0.75	1	1.7 A	10 - 80	52 - 29	1.4	5 - 52	4.0	5 - 52	5.0	5 - 14
VSP - MK 3/5	1.1	1.5	2.3 A	10 - 80	85 - 48	2.3	5 - 52	4.0	5 - 72	8.3	5 - 13
VSP - MK 3/6	1.5	2	2.8 A	10 - 80	101 - 56	2.7	5 - 53	4.0	5 - 65	9.7	5 - 19
VSP - MK 5/4	0.75	1	2.0 A	20 - 120	55 - 20	1.5	5 - 101	4.0	5 - 82	5.3	5 - 26
VSP - MK 5/5	1.1	1.5	2.2 A	20 - 120	69 - 21.5	1.8	5 - 108	4.0	5 - 99	6.7	5 - 13
VSP - MK 5/7	1.5	2	3.0 A	20 - 120	95 - 30	2.6	5 - 109	4.0	5 - 111	9.3	5 - 16
VSP - MK 5/8	2.2	3	3.5 A	20 - 120	108 - 34	2.9	5 - 109	4.0	5 - 115	10.6	5 - 14
VSP - MK 8/4	1.1	1.5	2.8 A	40 - 180	53 - 12	1.4	5 - 175	4.0	5 - 115	5.2	5 - 30
VSP - MK 8/5	1.5	2	3.4 A	40 - 180	68 - 15.5	1.8	5 - 175	4.0	5 - 138	6.6	5 - 45
VSP - MK 8/6	2.2	3	3.8 A	40 - 180	81 - 18.5	2.2	5 - 175	4.0	5 - 149	8.0	5 - 22

CURVE DI PRESTAZIONE

50 Hz

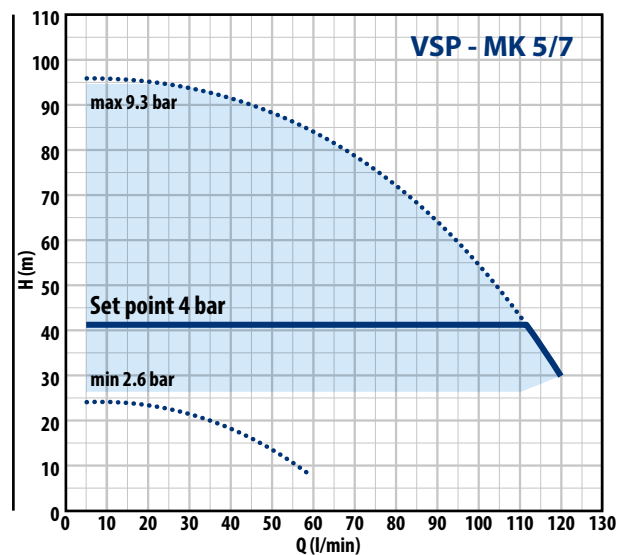
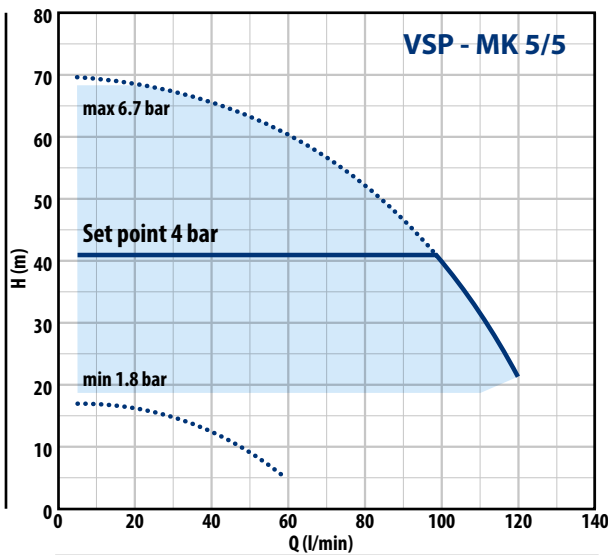
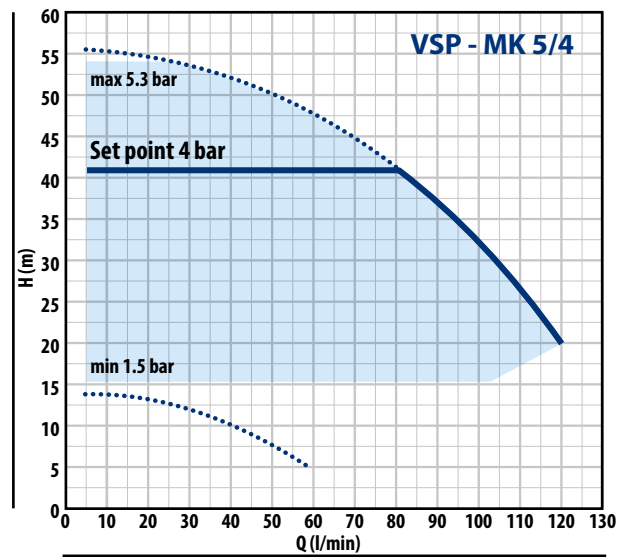
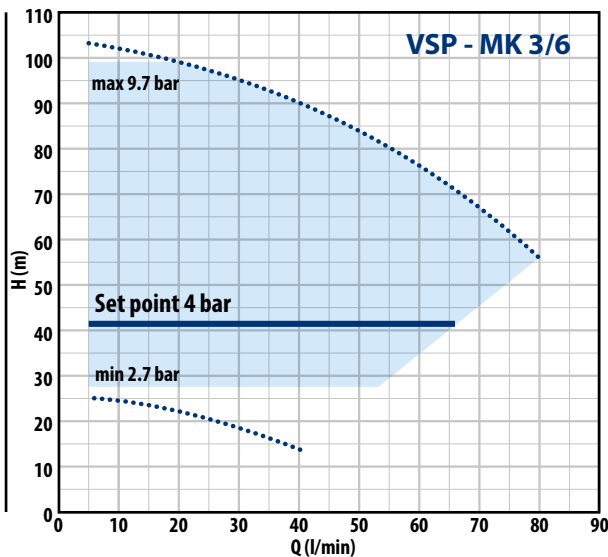
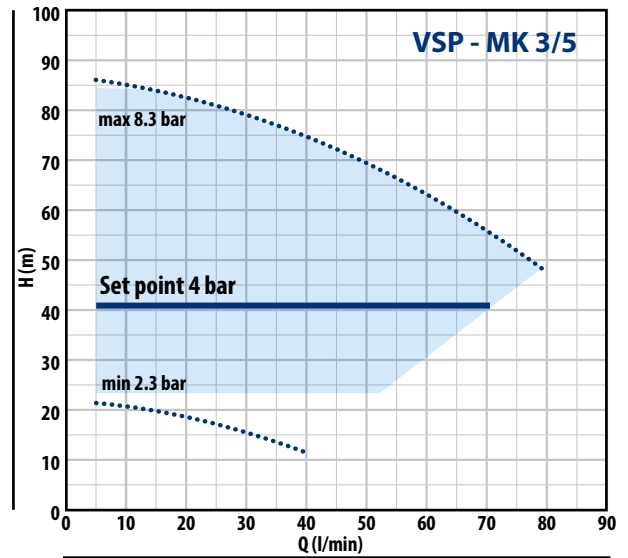
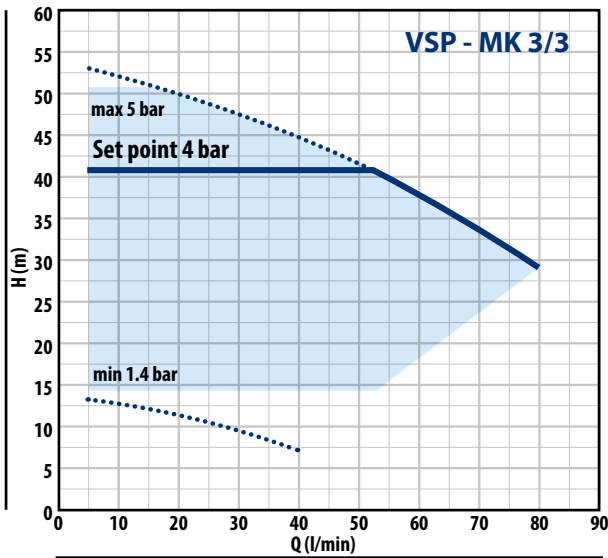

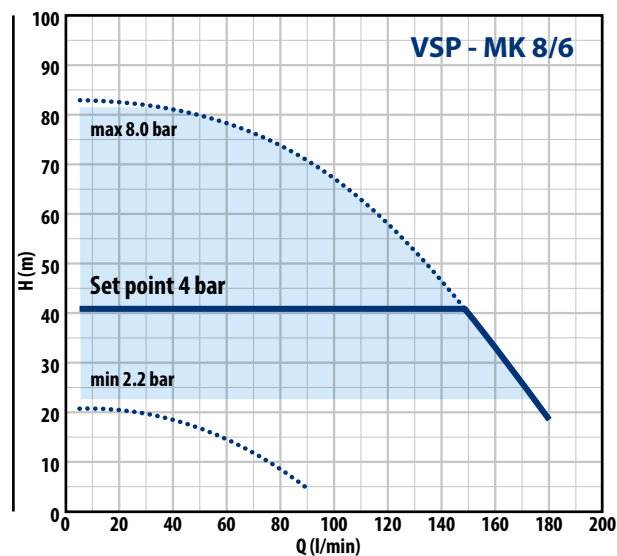
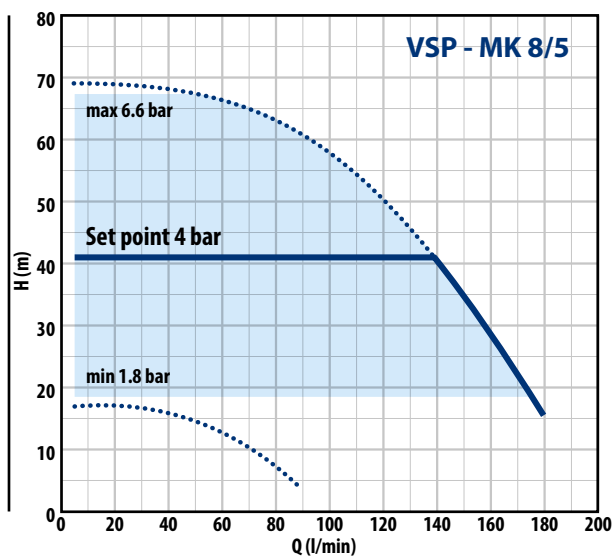
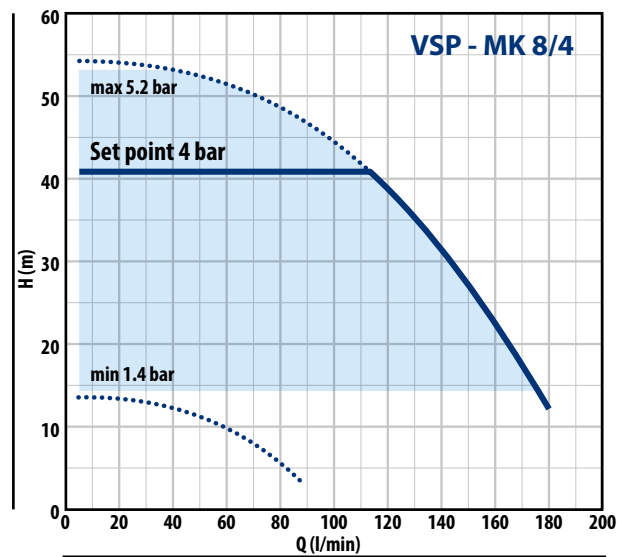
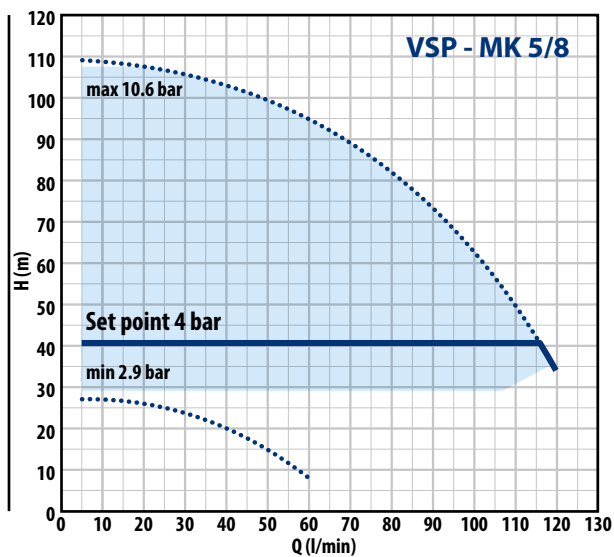

DIMENSIONI E PESI

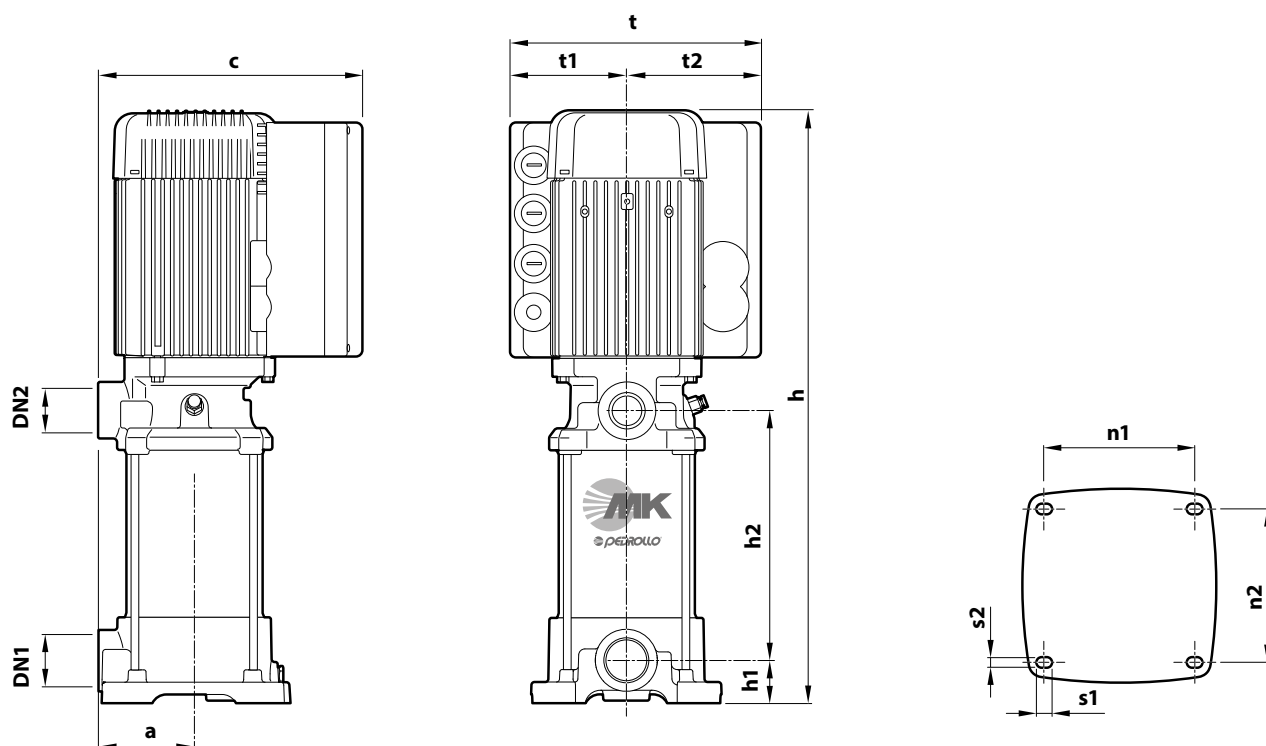

Monofase	TIPO		BOCCHIE		DIMENSIONI mm										kg				
	Trifase		DN1	DN2	a	c	h	h1	h2	t	t1	t2	n1	n2	s1	s2	1~	3~	
VSPm - MK 3/3	VSP - MK 3/3							447		132							23.3	23.3	
VSPm - MK 3/5	VSP - MK 3/5							501		186							25.5	25.5	
VSPm - MK 3/6	VSP - MK 3/6							528		213							27.3	27.3	
VSPm - MK 5/4	VSP - MK 5/4							474		159							23.8	23.8	
VSPm - MK 5/5	VSP - MK 5/5							501		186							25.2	25.2	
VSPm - MK 5/7	VSP - MK 5/7		1 1/4"	1"	93	255		555	41	240	242	113	129	143	146	14.5	10	28.3	28.3
-	VSP - MK 5/8							602		267							-	28.6	
VSPm - MK 8/4	VSP - MK 8/4							474		159							26.6	26.6	
VSPm - MK 8/5	VSP - MK 8/5							501		186							27.0	27.0	
-	VSP - MK 8/6							548		213							-	29.4	

VSP - HT-PRO

CAMPO DI PRESTAZIONE

50 Hz

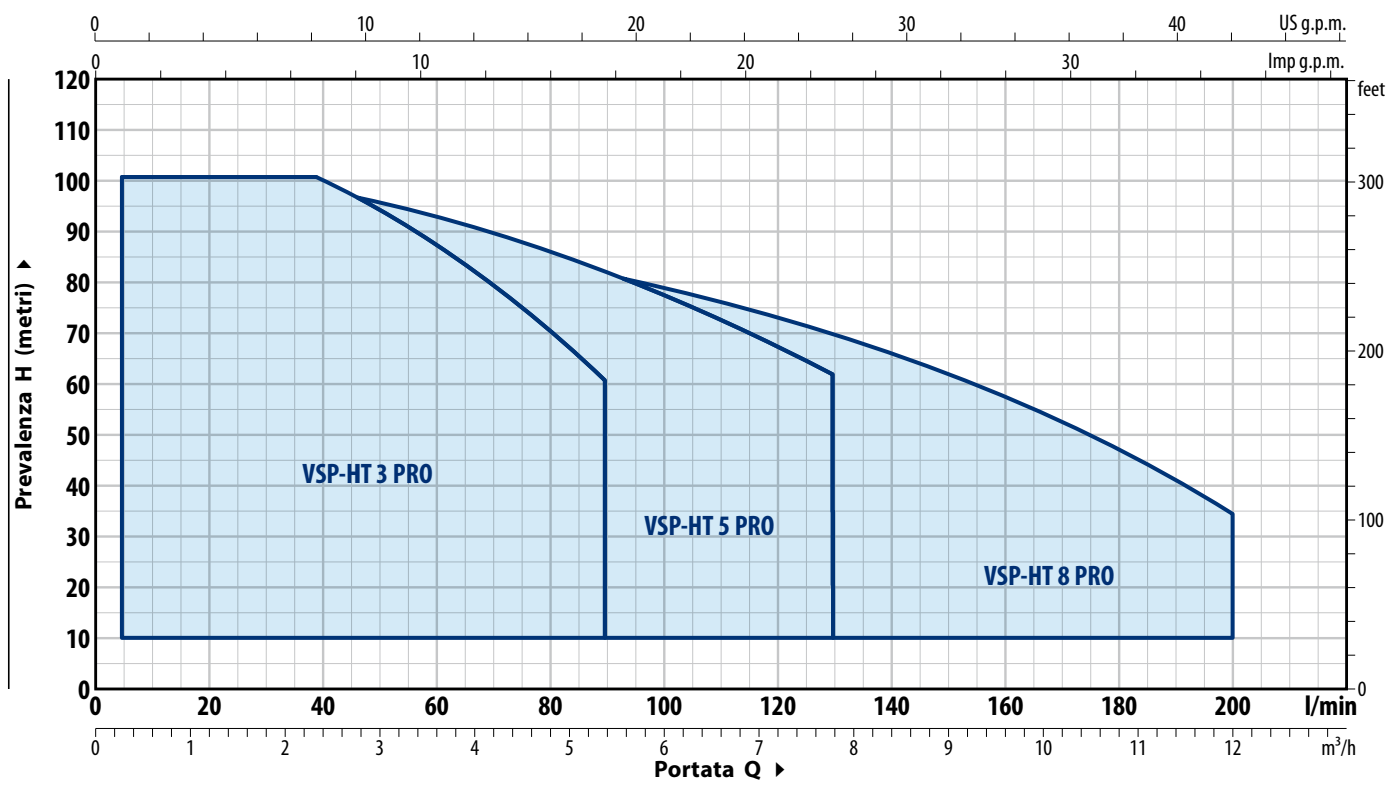

DATI TECNICI

TIPO	POTENZA P ₂		ASSORBIMENTI 230 V	PRESTAZIONI MAX		PRESTAZIONI (SET POINT REGOLABILE)					
	kW	HP		Q litri/min	H metri	Set Point Min		Set Point Taratura Std		Set Point Max	
						bar	l/min	bar	l/min	bar	l/min
Monofase											
VSPm - HT 3/4 PRO	0.75	1	7.5 A	5 - 90	65 - 35	1.6	5 - 58	4.0	5 - 80	6.0	5 - 28
VSPm - HT 3/5 PRO	1.1	1.5	9.0 A	5 - 90	80 - 44	2.0	5 - 58	4.0	5 - 85	7.5	5 - 30
VSPm - HT 3/6 PRO	1.5	2	10.5 A	5 - 90	96 - 52	2.4	5 - 60	4.0	5 - 75	9.0	5 - 29
VSPm - HT 5/2 PRO	0.75	1	7.0 A	5 - 130	35 - 20.5	0.8	5 - 80	2.0	5 - 130	3.2	5 - 48
VSPm - HT 5/3 PRO	1.1	1.5	8.0 A	5 - 130	51.5 - 31	1.3	5 - 82	4.0	5 - 91	4.8	5 - 32
VSPm - HT 5/4 PRO	1.5	2	9.5 A	5 - 130	68.5 - 41	1.7	5 - 84	4.0	5 - 130	6.4	5 - 45
VSPm - HT 8/3 PRO	1.1	1.5	8.5 A	5 - 200	47 - 17	1.1	5 - 158	4.0	5 - 95	4.4	5 - 60
VSPm - HT 8/4 PRO	1.5	2	10.0 A	5 - 200	62 - 23	1.5	5 - 160	4.0	5 - 148	5.9	5 - 60

TIPO	POTENZA P ₂		ASSORBIMENTI 400 V	PRESTAZIONI MAX		PRESTAZIONI (SET POINT REGOLABILE)					
	kW	HP		Q litri/min	H metri	Set Point Min		Set Point Taratura Std		Set Point Max	
						bar	l/min	bar	l/min	bar	l/min
Trifase											
VSP - HT 3/4 PRO	0.75	1	2.5 A	5 - 90	65 - 35	1.6	5 - 58	4.0	5 - 80	6.0	5 - 28
VSP - HT 3/5 PRO	1.1	1.5	3.0 A	5 - 90	80 - 44	2.0	5 - 58	4.0	5 - 85	7.5	5 - 30
VSP - HT 3/6 PRO	1.5	2	3.5 A	5 - 90	96 - 52	2.4	5 - 60	4.0	5 - 75	9.0	5 - 29
VSP - HT 3/7 PRO	1.8	2.5	4.2 A	5 - 90	112 - 61	2.8	5 - 60	4.0	5 - 70	10.0	5 - 40
VSP - HT 5/2 PRO	0.75	1	2.3 A	5 - 130	35 - 20.5	0.8	5 - 80	2.0	5 - 130	3.2	5 - 48
VSP - HT 5/3 PRO	1.1	1.5	2.4 A	5 - 130	51.5 - 31	1.3	5 - 82	4.0	5 - 91	4.8	5 - 32
VSP - HT 5/4 PRO	1.5	2	3.2 A	5 - 130	68.5 - 41	1.7	5 - 84	4.0	5 - 130	6.4	5 - 45
VSP - HT 5/5 PRO	1.8	2.5	4.0 A	5 - 130	85 - 51.5	2.1	5 - 83	4.0	5 - 112	8.0	5 - 45
VSP - HT 5/6 PRO	2.2	3	4.3 A	5 - 130	103 - 62	2.6	5 - 84	4.0	5 - 100	9.5	5 - 52
VSP - HT 8/3 PRO	1.1	1.5	3.0 A	5 - 200	47 - 17	1.1	5 - 158	4.0	5 - 95	4.4	5 - 60
VSP - HT 8/4 PRO	1.5	2	3.4 A	5 - 200	62 - 23	1.5	5 - 160	4.0	5 - 148	5.9	5 - 60
VSP - HT 8/5 PRO	1.8	2.5	4.0 A	5 - 200	78 - 28.5	1.8	5 - 155	4.0	5 - 175	7.3	5 - 60
VSP - HT 8/6 PRO	2.2	3	4.5 A	5 - 200	94 - 34.5	2.3	5 - 160	4.0	5 - 188	8.9	5 - 60

CURVE DI PRESTAZIONE

50 Hz

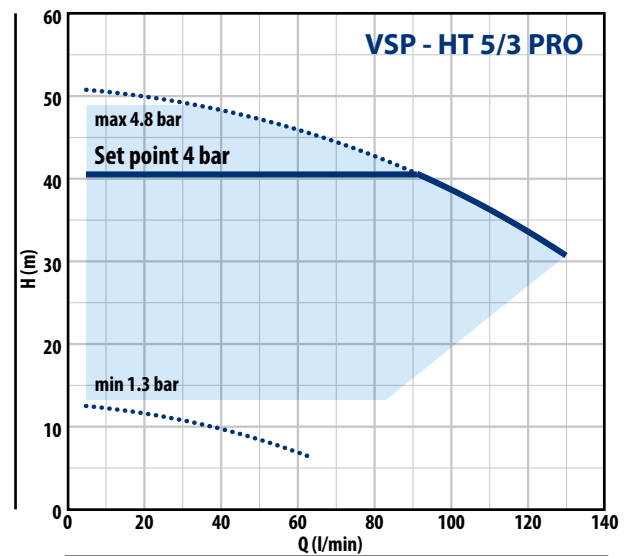
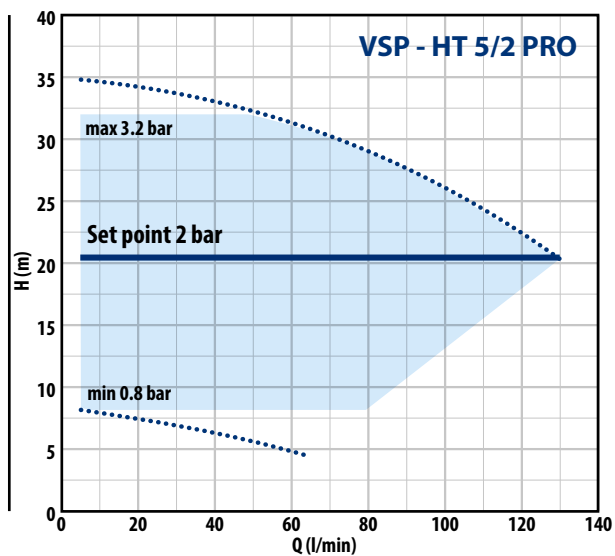
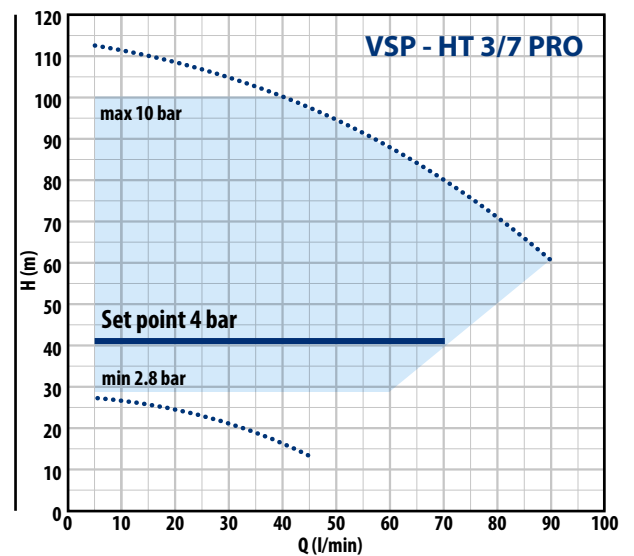
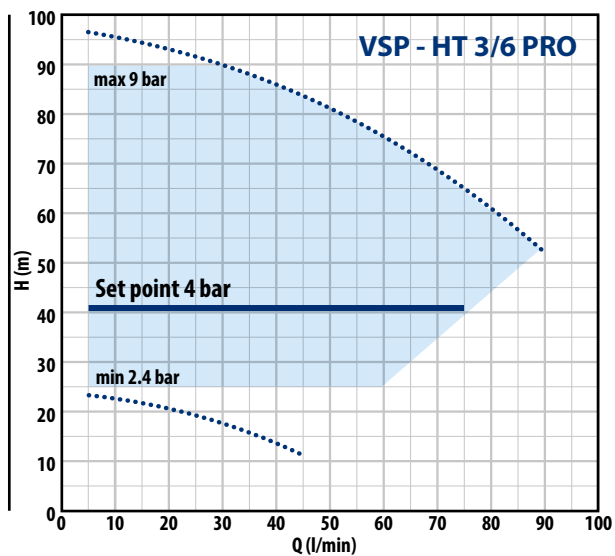
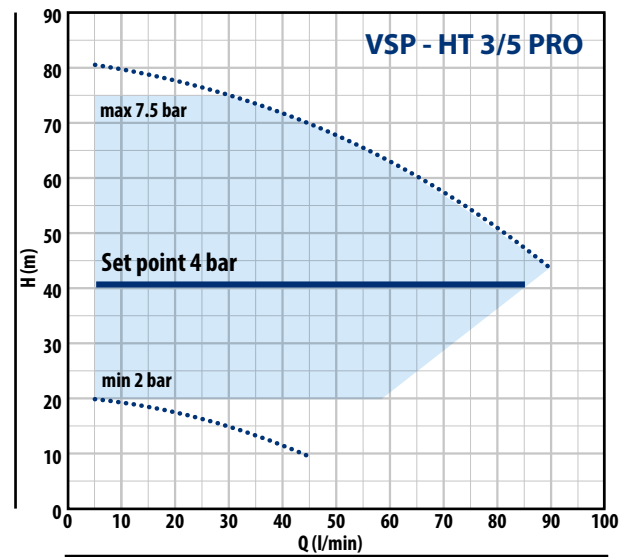
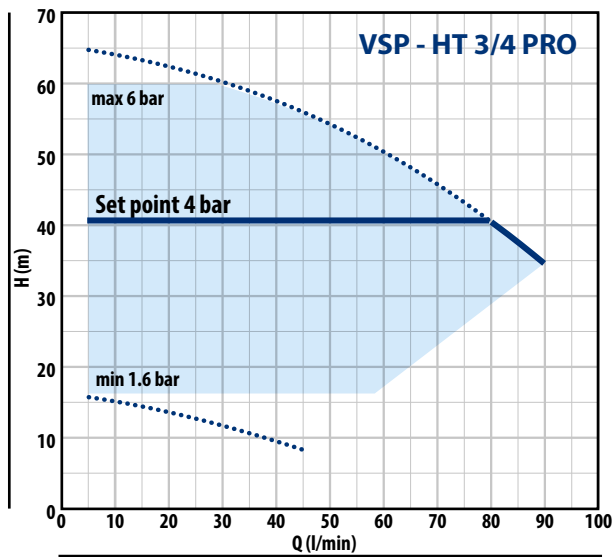

VSP - HT-PRO

CURVE DI PRESTAZIONE

50 Hz

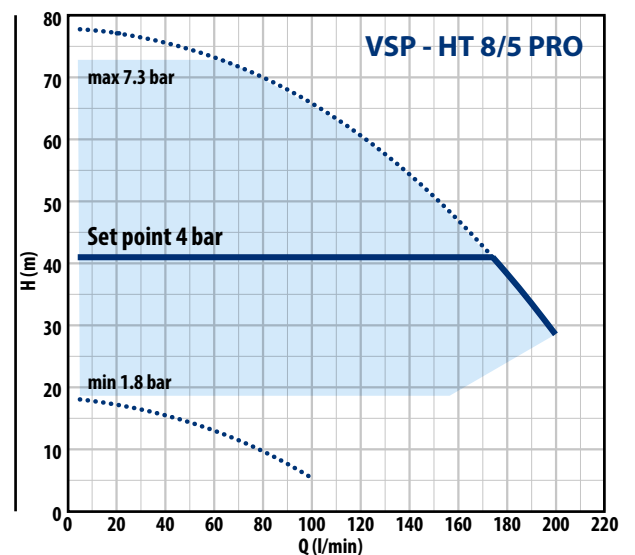
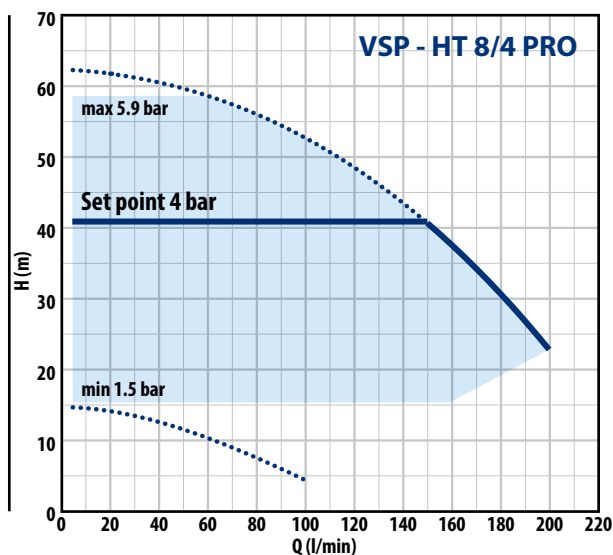
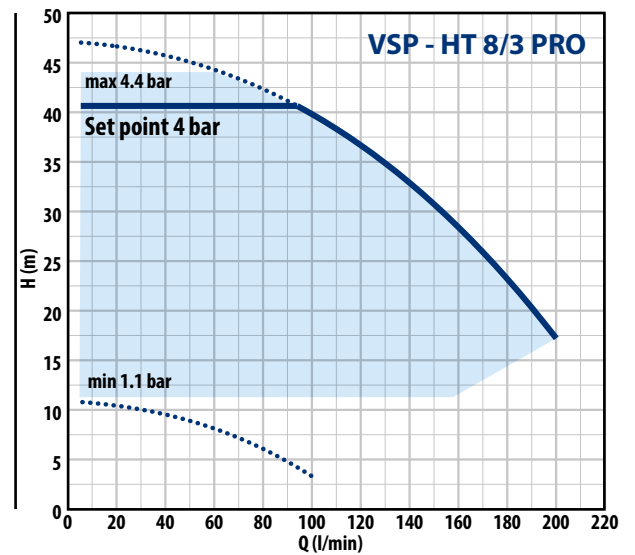
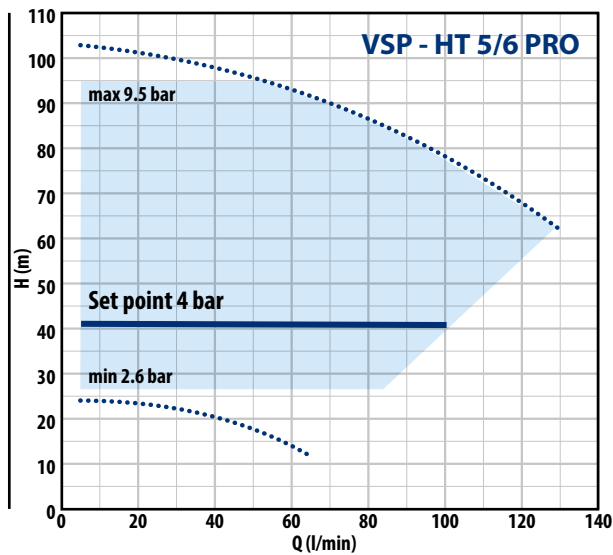
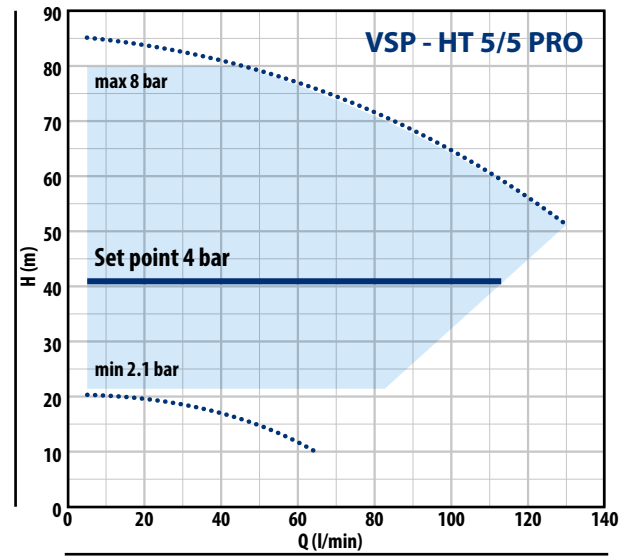
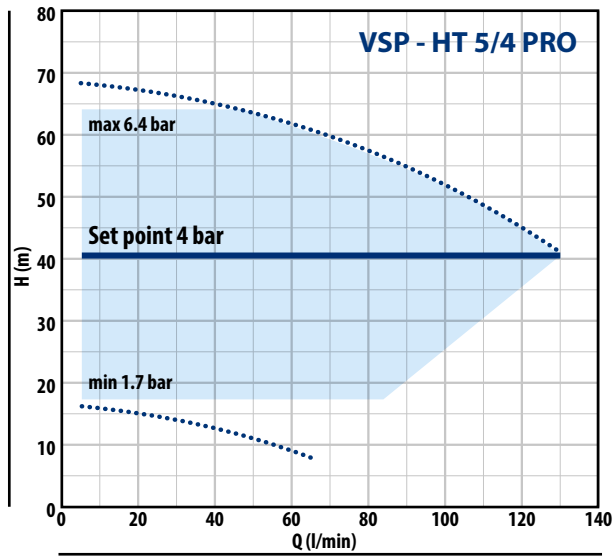

CURVE DI PRESTAZIONE

50 Hz

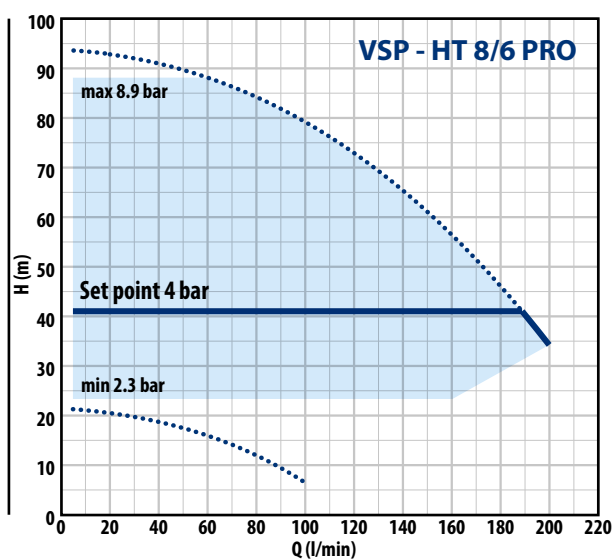

DIMENSIONI E PESI

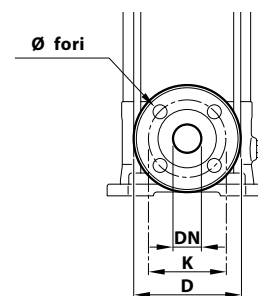
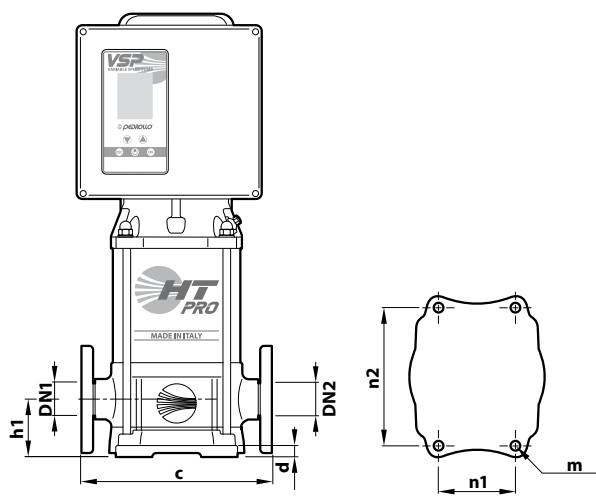
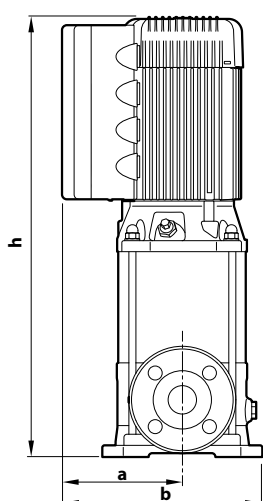

TIPO	DN	D	K	Ø
VSP	mm	mm	mm	mm
HT 3	25	115	85	14
HT 5	32	140	100	18
HT 8	40	150	110	

TIPO		BOCCHIE		DIMENSIONI mm								kg		
Monofase	Trifase	DN1	DN2	a	b	c	d	h	h1	n1	n2	m	1~	3~
VSPm - HT 3/4 PRO	VSP - HT 3/4 PRO	1"	1"					509					35.3	34.8
VSPm - HT 3/5 PRO	VSP - HT 3/5 PRO							535					35.5	35.0
VSPm - HT 3/6 PRO	VSP - HT 3/6 PRO							561					36.2	37.1
-	VSP - HT 3/7 PRO							607					-	41.2
VSPm - HT 5/2 PRO	VSP - HT 5/2 PRO	1 1/4"	1 1/4"	164	269	212	15	457	75	100	180	Ø 13	33.2	33.2
VSPm - HT 5/3 PRO	VSP - HT 5/3 PRO							483					33.4	33.4
VSPm - HT 5/4 PRO	VSP - HT 5/4 PRO							509	35.3				35.4	
-	VSP - HT 5/5 PRO							555	-				39.1	
-	VSP - HT 5/6 PRO	581	-	40.1										
VSPm - HT 8/3 PRO	VSP - HT 8/3 PRO	1 1/2"	1 1/2"			240		488	80				33.9	33.9
VSPm - HT 8/4 PRO	VSP - HT 8/4 PRO							514					35.8	35.9
-	VSP - HT 8/5 PRO							560					-	39.4
-	VSP - HT 8/6 PRO							586					-	40.2