

4SR 4" submersible pumps



※ The new 4SR-S series floating impeller pumps, with their advanced hydraulic design and patented innovations, deliver outstanding performance and efficiency. They are exceptionally resistant to sand-related wear, offering a durability 10 times higher than other global market pumps!

※ The new 4SR-S pumps feature a patented inductor that improves priming capabilities in wells with air/water mix or water containing gasses.

PERFORMANCE RANGE

- Flow rate up to **450 l/min** (27 m³/h)
- Head up to **576 m**

- Starts per hour: **20** at regular intervals
- Minimum motor cooling flow **8 cm/s**
- Continuous running duty **S1**

INSTALLATION AND USE

They are recommended for pumping clean water. Due to their high efficiency and reliability, they are suitable for **domestic, civil and industrial** applications, for water distribution coupled with autoclaves, for irrigation, for washing systems, for pressure boosting, etc.

※ KEY FEATURES

Low energy consumption and remarkable durability, even in the presence of sand (up to **200 g/m³**), thanks to an innovative patented hydraulics system..

APPLICATION LIMITS

- Liquid temperature up to **+40 °C**
- Maximum sand content:
 - **200 g/m³** for 4SR-S
 - **150 g/m³** for 4SR-N
- Maximum operating depth below water level:
 - **200 m** with 4PD motors
 - **300 m** with 4PS motors
- Operation:
 - in vertical position
 - horizontally with the following limits:
 - 4SR-S** - 1 / 1.5 / 2 / 4 up to **23 stages**
 - 4SR-S** 6 / 8 up to **17 stages**
 - 4SR-N** 10 / 12 / 15 up to **13 stages**
 - 4SR-N** 18 up to **9 stadi**

INCLUDES

ELECTRIC MOTOR

- ※ Three-phase 400 V - 50 Hz
- ※ Single-phase 230 V - 50 Hz
- ※ **Capacitor included in packaging**
- ※ Power cable:
 - **2 m** for power ratings from 0.75 to 2.2 kW
 - **3.6 m** for power ratings from 3 to 7.5 kW.

※ **4SR 18-N** without check valve

AVAILABLE UPON REQUEST

- ※ Different voltage requirements 60 Hz frequency
- ※ Cooling jacket kit
- ※ 4SR 18-N with check valve

PATENTS:

- European Patent No. EP3123031
- European Patent No. EP2419642 for 4SR-S
- Patent No. 10202100003057 for 4SR-S
- **4SR-S**® is a registered trademark No. 018702382
- **SABBIA**® is registered trademark no. 5456231



CURVES AND PERFORMANCE DATA

50 Hz

4SR 1-S

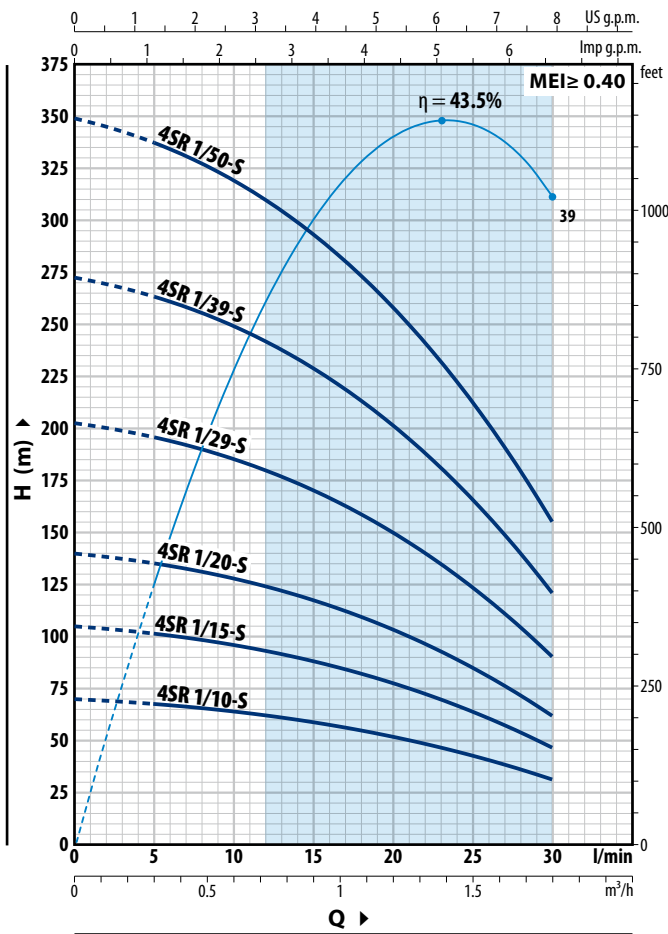

4SR 1.5-S

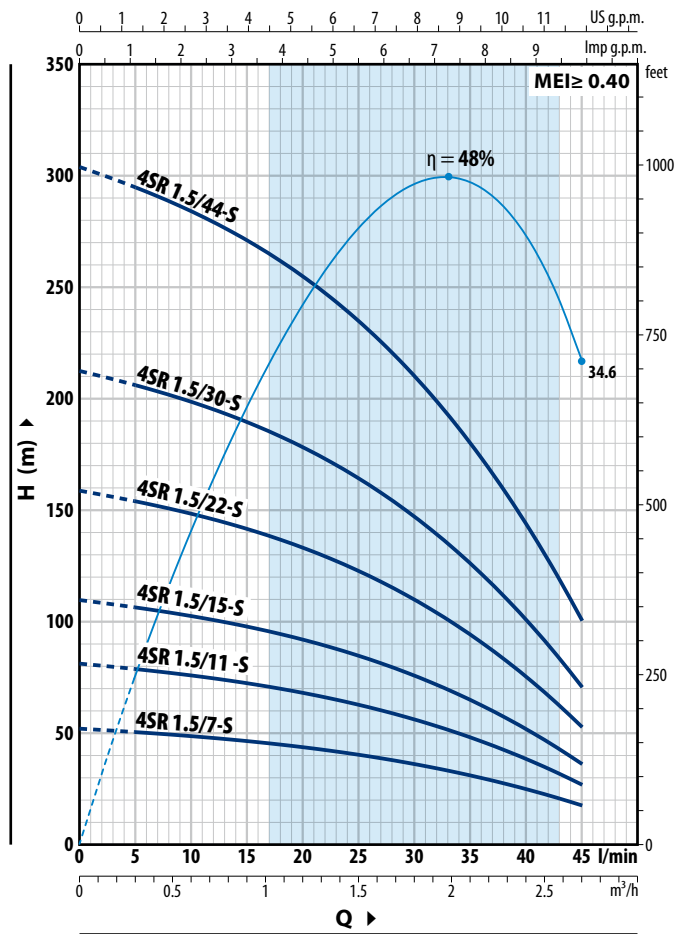

4SR 1-S

TYPE		POWER (P ₂)		Q	H metres						
Single-phase	Three-phase	kW	HP		m ³ /h	0	0.3	0.6	0.9	1.2	1.5
4SRm 1/10 - S	4SR 1/10 - S	0.37	0.50	0	0	5	10	15	20	25	30
4SRm 1/15 - S	4SR 1/15 - S	0.55	0.75	0.3	70	67.5	64	58.5	51.5	42.5	31
4SRm 1/20 - S	4SR 1/20 - S	0.75	1	0.6	105	101	96	88	78	64	46.5
4SRm 1/29 - S	4SR 1/29 - S	1.1	1.5	0.9	140	135	128	117	103	85	62
4SRm 1/39 - S	4SR 1/39 - S	1.5	2	1.2	203	196	185	170	150	123	90
4SRm 1/50 - S	4SR 1/50 - S	2.2	3	1.5	273	264	249	229	202	166	121
				1.8	350	338	320	294	258	213	155

4SR 1.5-S

TYPE		POWER (P ₂)		Q	H metres										
Single-phase	Three-phase	kW	HP		m ³ /h	0	0.3	0.6	0.9	1.2	1.5	1.8	2.1	2.4	2.7
4SRm 1.5/7 - S	4SR 1.5/7 - S	0.37	0.50	0	0	5	10	15	20	25	30	35	40	45	
4SRm 1.5/11 - S	4SR 1.5/11 - S	0.55	0.75	0.3	51.5	50	48.5	46	43.5	40	36	30.5	24.5	17	
4SRm 1.5/15 - S	4SR 1.5/15 - S	0.75	1	0.6	81	78	75	72	67.5	62.5	55.5	48	38	26.5	
4SRm 1.5/22 - S	4SR 1.5/22 - S	1.1	1.5	0.9	109	106	102	97	92	84	76	64.5	51.5	36	
4SRm 1.5/30 - S	4SR 1.5/30 - S	1.5	2	1.2	158	154	148	141	133	122	109	94	75	52.5	
4SRm 1.5/44 - S	4SR 1.5/44 - S	2.2	3	1.5	213	206	199	190	178	164	147	126	100	70	
				1.8	304	295	284	271	255	235	210	180	144	100	

Q = Flow rate H = Total manometric head

Performance curves comply with EN ISO 9906 Grade 3B tolerance limits.

4SR-S 4" submersible pumps

CURVES AND PERFORMANCE DATA

50 Hz

4SR 2-S

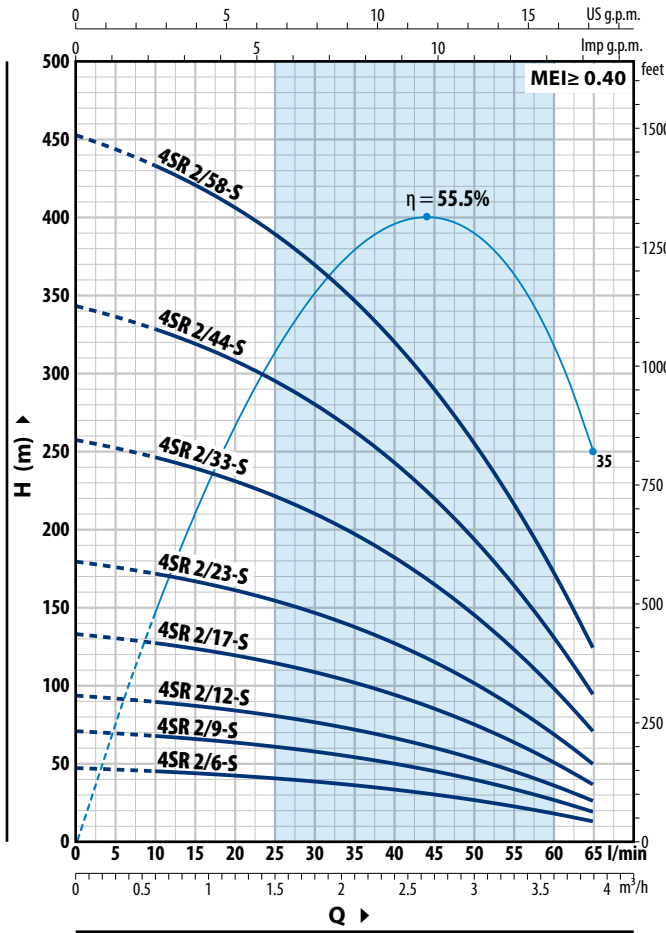

4SR 4-S

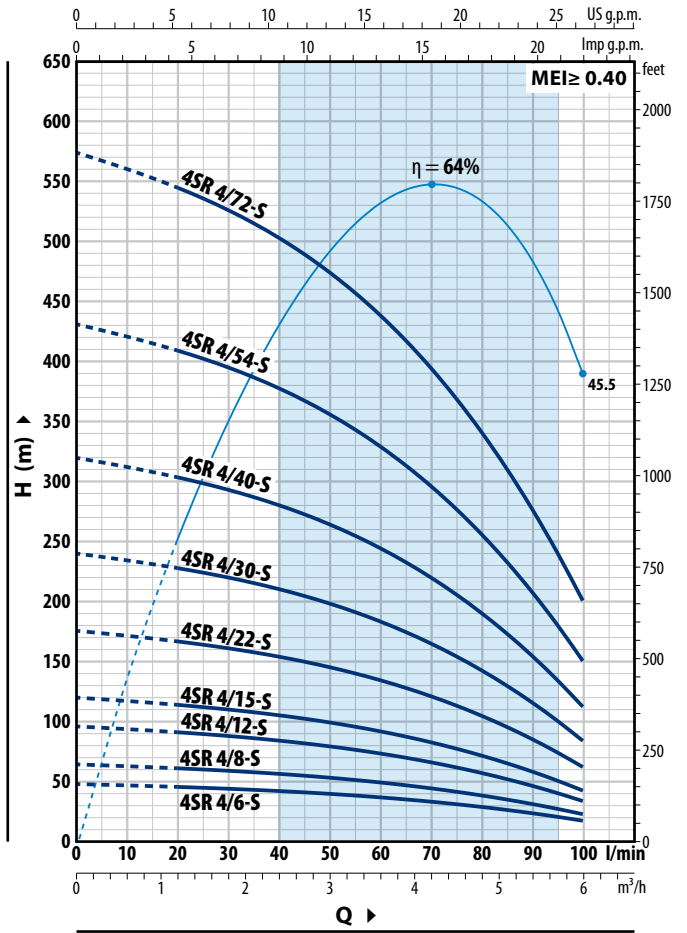

4SR 2-S

TYPE		POWER (P ₂)		Q	H metres								
Single-phase	Three-phase	kW	HP		m ³ /h	0	0.6	1.2	1.8	2.4	3.0	3.6	3.9
				l/min	0	10	20	30	40	50	60	65	
4SRm 2/6 - S	4SR 2/6 - S	0.37	0.50		47	45	42	38	33	26.4	18	13	
4SRm 2/9 - S	4SR 2/9 - S	0.55	0.75		70	67	63	57.5	49.5	39.5	26.8	19.5	
4SRm 2/12 - S	4SR 2/12 - S	0.75	1		94	90	84	76	66	53	36	25.5	
4SRm 2/17 - S	4SR 2/17 - S	1.1	1.5		133	127	119	108	94	75	50.5	36.5	
4SRm 2/23 - S	4SR 2/23 - S	1.5	2		179	172	161	146	127	101	68.5	49	
4SRm 2/33 - S	4SR 2/33 - S	2.2	3		257	246	231	210	182	145	98	71	
-	4SR 2/44 - S	3	4		343	328	308	280	243	194	131	94	
-	4SR 2/58 - S	4	5.5		452	433	406	369	320	256	173	124	

4SR 4-S

TYPE		POWER (P ₂)		Q	H metres									
Single-phase	Three-phase	kW	HP		m ³ /h	0	1.2	1.8	2.4	3.0	3.6	4.2	4.8	5.4
				l/min	0	20	30	40	50	60	70	80	90	100
4SRm 4/6 - S	4SR 4/6 - S	0.55	0.75		48	45.5	44	42	39.5	36.5	33	28.5	23.2	17
4SRm 4/8 - S	4SR 4/8 - S	0.75	1		64	60.5	58.5	56	53	49	44	38	31	22.5
4SRm 4/12 - S	4SR 4/12 - S	1.1	1.5		96	91	88	84	79	73	66	57	46.5	33.5
4SRm 4/15 - S	4SR 4/15 - S	1.5	2		120	114	110	105	99	92	83	71	58	42
4SRm 4/22 - S	4SR 4/22 - S	2.2	3		176	167	161	154	145	134	121	105	85	61.5
-	4SR 4/30 - S	3	4		240	228	220	210	198	183	165	143	116	84
-	4SR 4/40 - S	4	5.5		320	304	293	280	264	244	220	190	154	112
-	4SR 4/54 - S	5.5	7.5		432	410	396	379	357	330	297	257	209	151
-	4SR 4/72 - S	7.5	10		576	547	528	505	476	440	396	342	278	202

Q = Flow rate H = Total manometric head

Performance curves comply with EN ISO 9906 Grade 3B tolerance limits.

CURVES AND PERFORMANCE DATA

50 Hz

4SR 6-S

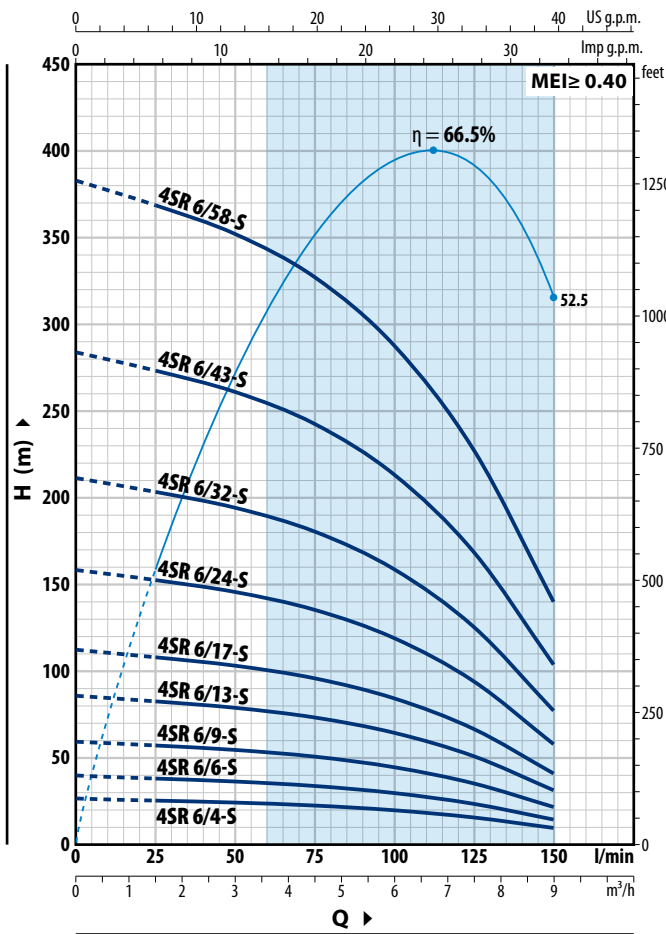

4SR 8-S

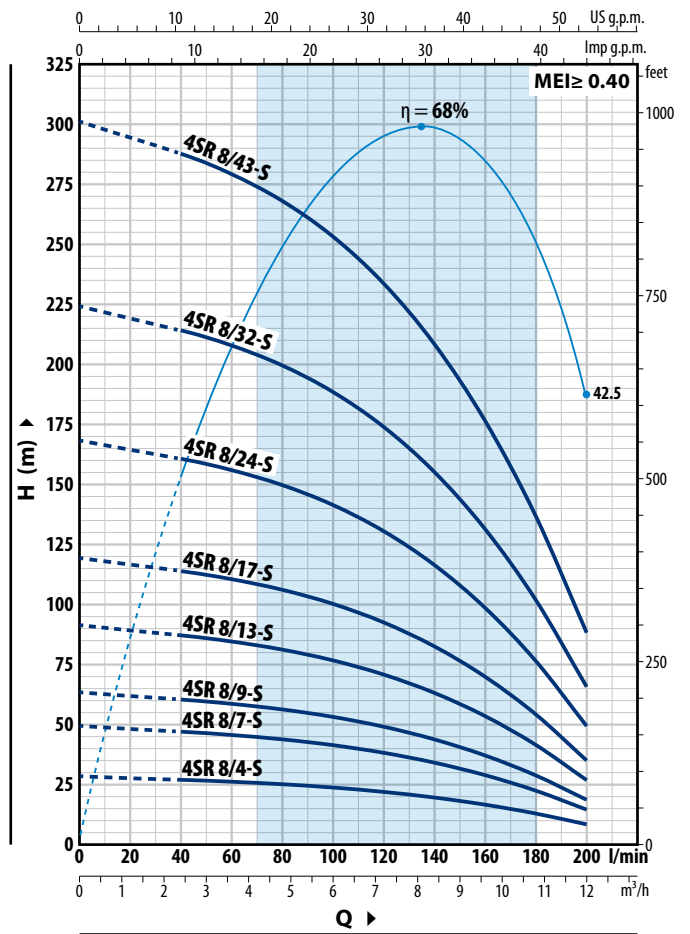

4SR 6-S

TYPE		POWER (P ₂)		Q	H metres							
Single-phase	Three-phase	kW	HP		m ³ /h	0	1.5	3.0	4.5	6.0	7.5	9.0
4SRm 6/4 - S	4SR 6/4 - S	0.55	0.75	0	0	25	50	75	100	125	150	
4SRm 6/6 - S	4SR 6/6 - S	0.75	1	26.5	25.5	24.3	22.5	19.8	15.7	9.5		
4SRm 6/9 - S	4SR 6/9 - S	1.1	1.5	39.5	38	36.5	34	29.5	23.5	14.5		
4SRm 6/13 - S	4SR 6/13 - S	1.5	2	59.5	57	54.5	50.5	44.5	35.5	21.5		
4SRm 6/17 - S	4SR 6/17 - S	2.2	3	86	83	79	73	64.5	51	31.5		
-	4SR 6/24 - S	3	4	112	108	103	96	84	66.5	41		
-	4SR 6/32 - S	4	5.5	158	152	146	135	119	94	58		
-	4SR 6/43 - S	5.5	7.5	211	203	194	180	159	125	77		
-	4SR 6/58 - S	7.5	10	284	273	261	242	213	168	104		
-				383	368	352	327	287	227	140		

4SR 8-S

TYPE		POWER (P ₂)		Q	H metres									
Single-phase	Three-phase	kW	HP		m ³ /h	0	2.4	3.6	4.8	6.0	7.2	8.4	9.6	10.8
4SRm 8/4 - S	4SR 8/4 - S	0.75	1	0	0	40	60	80	100	120	140	160	180	200
4SRm 8/7 - S	4SR 8/7 - S	1.1	1.5	28	27	26	25	23.6	21.8	19.4	16.4	12.7	8	
4SRm 8/9 - S	4SR 8/9 - S	1.5	2	49	47	45.5	43.5	41.5	38	34	28.5	22.3	14.5	
4SRm 8/13 - S	4SR 8/13 - S	2.2	3	63	60.5	58.5	56	53	49	43.5	37	28.5	18.5	
-	4SR 8/17 - S	3	4	91	87	85	81	77	71	63	53.5	41.5	26.5	
-	4SR 8/24 - S	4	5.5	119	114	111	106	100	92	82	70	54	35	
-	4SR 8/32 - S	5.5	7.5	168	161	156	150	141	131	116	99	76	49	
-	4SR 8/43 - S	7.5	10	224	214	208	200	189	174	155	131	102	65.5	
-				301	288	280	268	253	234	209	177	137	88	

Q = Flow rate H = Total manometric head

Performance curves comply with EN ISO 9906 Grade 3B tolerance limits.

4SR-N 4" submersible pumps

CURVES AND PERFORMANCE DATA

50 Hz

4SR 10-N

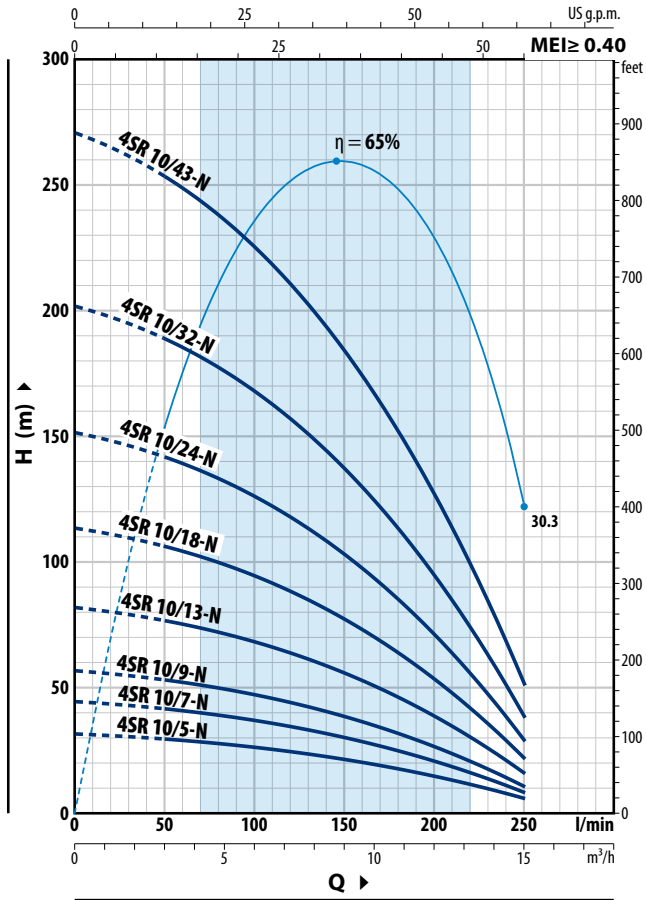

4SR 12-N

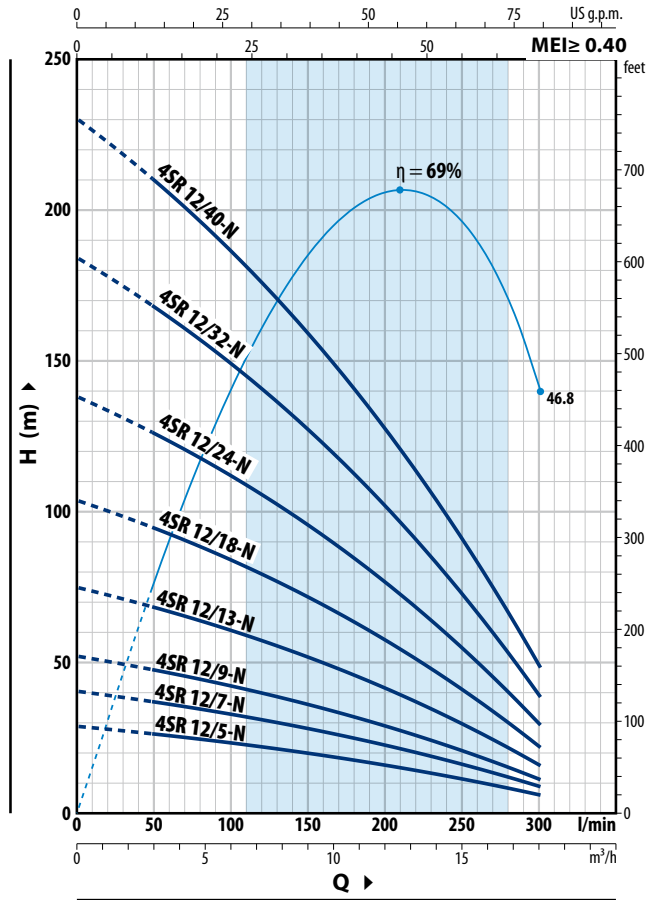

4SR 10-N

TYPE		POWER (P ₂)		Q	H metres									
Single-phase	Three-phase	kW	HP		m ³ /h	0	3.0	6.0	7.5	9.0	10.5	12.0	13.5	15.0
				l/min	0	50	100	125	150	175	200	225	250	
4SRm 10/5 - N	4SR 10/5 - N	0.75	1	H metres	31.5	29.5	26.2	24	21.4	18.3	14.7	10.6	6	
4SRm 10/7 - N	4SR 10/7 - N	1.1	1.5		44	41.5	36.5	33.5	30	25.6	20.6	14.8	8.5	
4SRm 10/9 - N	4SR 10/9 - N	1.5	2		56.5	53	47	43	38.5	33	26.5	19.1	10.5	
4SRm 10/13 - N	4SR 10/13 - N	2.2	3		82	77	68	62.5	55.5	47.5	38	27.5	15.5	
-	4SR 10/18 - N	3	4		113	106	94	86	77	66	53	38	21	
-	4SR 10/24 - N	4	5.5		151	141	126	115	103	88	71	51	28.5	
-	4SR 10/32 - N	5.5	7.5		202	189	168	154	137	117	94	68	38	
-	4SR 10/43 - N	7.5	10		271	254	226	206	184	157	126	91	51	

4SR 12-N

TYPE		POWER (P ₂)		Q	H metres							
Single-phase	Three-phase	kW	HP		m ³ /h	0	3	6	9	12	15	18
				l/min	0	50	100	150	200	250	300	
4SRm 12/5 - N	4SR 12/5 - N	0.75	1	H metres	29	26	23.2	19.8	15.9	11.3	6	
4SRm 12/7 - N	4SR 12/7 - N	1.1	1.5		40.5	36.5	32.5	27.5	22.2	15.8	8.5	
4SRm 12/9 - N	4SR 12/9 - N	1.5	2		52	47	42	35.5	28.5	20.3	11	
4SRm 12/13 - N	4SR 12/13 - N	2.2	3		75	68	60.5	51.5	41	29.5	15.5	
-	4SR 12/18 - N	3	4		104	94	84	71	57	40.5	21.5	
-	4SR 12/24 - N	4	5.5		138	126	112	95	76	54	29	
-	4SR 12/32 - N	5.5	7.5		184	168	149	127	101	72	38.5	
-	4SR 12/40 - N	7.5	10		230	210	186	159	127	90	48	

Q = Flow rate H = Total manometric head

Performance curves comply with EN ISO 9906 Grade 3B tolerance limits.

CURVES AND PERFORMANCE DATA

50 Hz

4SR 15-N

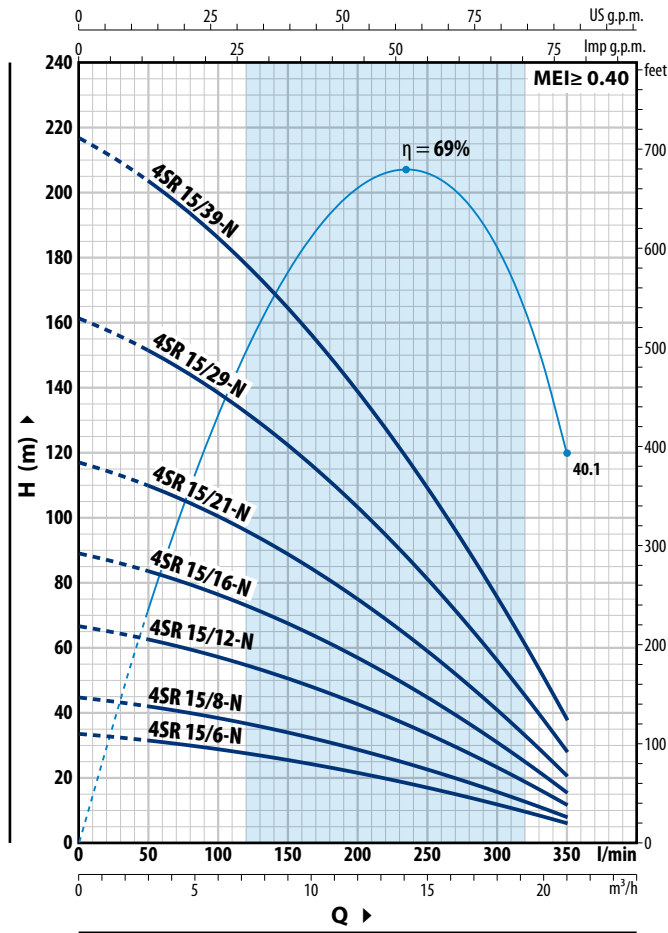

4SR 18-N

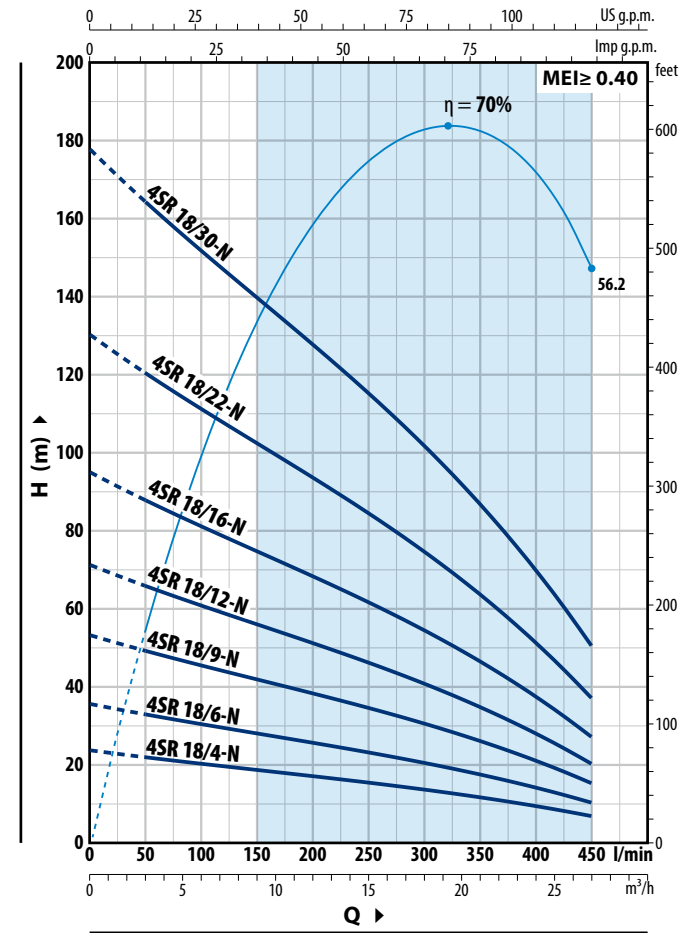

4SR 15-N

TYPE		POWER (P ₂)		Q	H metres								
Single-phase	Three-phase	kW	HP		m ³ /h	0	3	6	9	12	15	18	21
4SRm 15/6 - N	4SR 15/6 - N	1.1	1.5	l/min	0	50	100	150	200	250	300	350	
4SRm 15/8 - N	4SR 15/8 - N	1.5	2		33.5	31.5	28.5	25.3	21.3	16.7	11.6	6	
4SRm 15/12 - N	4SR 15/12 - N	2.2	3		44.5	41.5	38	33.5	28.5	22.3	15.4	7.5	
-	4SR 15/16 - N	3	4		66.5	62.5	57	50.5	42.5	33.5	23.1	11.5	
-	4SR 15/21 - N	4	5.5		89	83	76	67.5	57	44.5	31	15.5	
-	4SR 15/29 - N	5.5	7.5		117	110	100	88	75	58.5	40.5	20	
-	4SR 15/39 - N	7.5	10		161	151	138	122	103	81	56	28	
					217	203	186	164	139	109	75	37.5	

4SR 18-N (*)

TYPE		POWER (P ₂)		Q	H metres									
Single-phase	Three-phase	kW	HP		m ³ /h	0	3	6	9	12	15	18	21	24
4SRm 18/4 - N	4SR 18/4 - N	1.1	1.5	l/min	0	50	100	150	200	250	300	350	400	450
4SRm 18/6 - N	4SR 18/6 - N	1.5	2		23.5	22	20.3	18.7	17.1	15.4	13.6	11.5	9.3	7
4SRm 18/9 - N	4SR 18/9 - N	2.2	3		35.5	33	30.5	28	25.6	23.1	20.4	17.5	14	10
-	4SR 18/12 - N	3	4		53.5	49.5	45.5	42	38.5	34.5	30.5	26	21	15
-	4SR 18/16 - N	4	5.5		71	66	61	56	51	46	41	35	28	20.5
-	4SR 18/22 - N	5.5	7.5		95	88	81	75	68	61.5	54.5	46.5	37.5	27
-	4SR 18/30 - N	7.5	10		131	121	111	103	94	85	75	64	51.5	37
					178	165	152	140	128	115	102	87	70	50.5

Q = Flow rate H = Total manometric head

Performance curves comply with EN ISO 9906 Grade 3B tolerance limits.

(*) Performance curves without check valve

4SR 4" submersible pumps

MATERIALS AND COMPONENTS

1 Delivery port	Micro-cast AISI 304 stainless steel with thread according to ISO 228/1
2 Check valve	Stainless steel AISI 304
3 Motor bracket	Stainless steel AISI 304 , sized to NEMA standards
4 Impeller	Delrin® for 4SR-S, Noryl™ for 4SR-N
5 Diffuser	Noryl™
6 Stadium box	Stainless steel AISI 304
7 Pump shaft	Stainless steel AISI 304
8 Pump bearings	Made of AISI 316L stainless steel coated with chromium oxide to resist sand
9 Tow coupling	Stainless steel
10 Filter	Stainless steel AISI 304
11 Cable sheath	Stainless steel AISI 304
12 Motor 4"	※ 4PD = rewindable oil filled motor ※ 4PS = encapsulated water filled motor

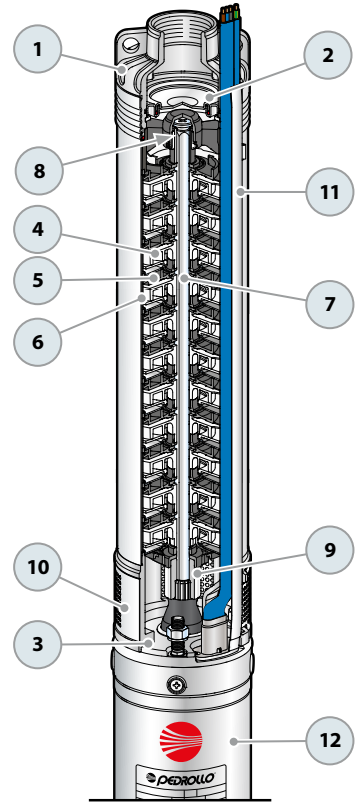

DIMENSIONS AND WEIGHTS (single-phase models)

TYPE Single-phase ※	DN	DIMENSIONS mm			kg	TYPE Single-phase ※	DN	DIMENSIONS mm			kg		
		h1	h2	h3				h1	h2	h3			
4SRm 1/10 - S - PD	1 1/4"	362	311	673	10.8	4SRm 1/10 - S - PS	1 1/4"	362	237	599	12.3		
4SRm 1/15 - S - PD		488	331	819	13.2	4SRm 1/15 - S - PS		488	257	745	14.4		
4SRm 1/20 - S - PD		588	356	944	15.9	4SRm 1/20 - S - PS		588	272	860	16.6		
4SRm 1/29 - S - PD		767	396	1163	19.9	4SRm 1/29 - S - PS		767	312	1079	20.6		
4SRm 1/39 - S - PD		992	437	1429	24.4	4SRm 1/39 - S - PS		992	352	1344	25		
4SRm 1/50 - S - PD		1284	492	1776	31.3	4SRm 1/50 - S - PS		1284	402	1686	30.6		
4SRm 1.5/7 - S - PD		303	311	614	10.1	4SRm 1.5/7 - S - PS		303	237	540	10.1		
4SRm 1.5/11 - S - PD		382	331	713	11.8	4SRm 1.5/11 - S - PS		382	257	639	12.2		
4SRm 1.5/15 - S - PD		488	356	844	14.0	4SRm 1.5/15 - S - PS		488	272	760	14.8		
4SRm 1.5/22 - S - PD		627	396	1023	17.8	4SRm 1.5/22 - S - PS		627	312	939	18.4		
4SRm 1.5/30 - S - PD		787	437	1224	21.4	4SRm 1.5/30 - S - PS		787	352	1139	22.6		
4SRm 1.5/44 - S - PD		1163	492	1655	29.2	4SRm 1.5/44 - S - PS		1163	402	1565	28.8		
4SRm 2/6 - S - PD		2"	283	311	594	10.0		4SRm 2/6 - S - PS	2"	283	237	520	10.2
4SRm 2/9 - S - PD			343	331	674	11.4		4SRm 2/9 - S - PS		343	257	600	11.8
4SRm 2/12 - S - PD			402	356	758	13.3		4SRm 2/12 - S - PS		402	272	674	14.0
4SRm 2/17 - S - PD			528	396	924	16.1		4SRm 2/17 - S - PS		528	312	840	17.0
4SRm 2/23 - S - PD	647		437	1084	20.1	4SRm 2/23 - S - PS	647	352		999	20.6		
4SRm 2/33 - S - PD	873		492	1365	24.9	4SRm 2/33 - S - PS	873	402		1275	24.8		
4SRm 4/6 - S - PD	313		331	644	11.2	4SRm 4/6 - S - PS	313	257		570	11.5		
4SRm 4/8 - S - PD	363		356	719	12.9	4SRm 4/8 - S - PS	363	272		635	13.6		
4SRm 4/12 - S - PD	462		396	858	15.5	4SRm 4/12 - S - PS	462	312		774	15.3		
4SRm 4/15 - S - PD	563		437	1000	18.4	4SRm 4/15 - S - PS	563	352		915	18.8		
4SRm 4/22 - S - PD	737		492	1229	23.2	4SRm 4/22 - S - PS	737	402		1139	24.0		
4SRm 6/4 - S - PD	2"		289	331	620	11.0	4SRm 6/4 - S - PS	2"		289	257	546	11.1
4SRm 6/6 - S - PD			352	356	708	12.7	4SRm 6/6 - S - PS			352	272	624	13.2
4SRm 6/9 - S - PD			446	396	842	15.2	4SRm 6/9 - S - PS			446	312	758	15.8
4SRm 6/13 - S - PD			598	437	1035	18.4	4SRm 6/13 - S - PS			598	352	950	19.0
4SRm 6/17 - S - PD			723	492	1215	22.7	4SRm 6/17 - S - PS			723	402	1125	22.8
4SRm 8/4 - S - PD		289	356	645	12.1	4SRm 8/4 - S - PS	289		272	561	12.3		
4SRm 8/7 - S - PD		382	396	778	15.0	4SRm 8/7 - S - PS	382		312	694	15.4		
4SRm 8/9 - S - PD		446	437	883	17.0	4SRm 8/9 - S - PS	446		352	798	17.8		
4SRm 8/13 - S - PD	598	492	1090	21.0	4SRm 8/13 - S - PS	598	402	1000	20.2				

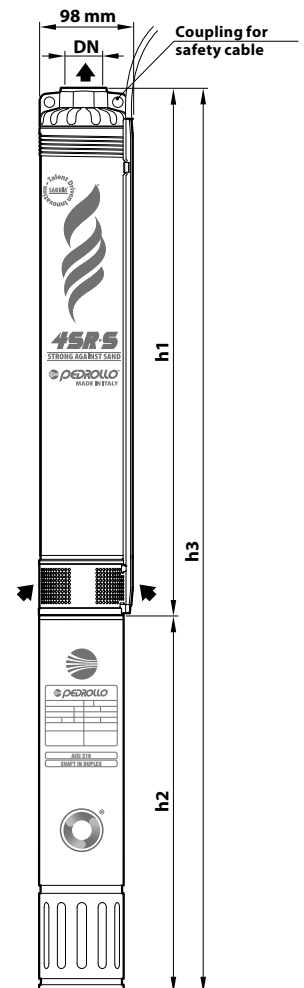

DIMENSIONS AND WEIGHTS (three-phase models)

TYPE	DN	DIMENSIONS mm			kg	TYPE	DN	DIMENSIONS mm			kg
Three-phase ※		h1	h2	h3		Three-phase ※		h1	h2	h3	
4SR 1/10 - S - PD	1 1/4"	362	311	673	10.6	4SR 1/10 - S - PS	1 1/4"	362	237	599	12.2
4SR 1/15 - S - PD		488	331	819	13.5	4SR 1/15 - S - PS		488	237	725	13.9
4SR 1/20 - S - PD		588	356	944	14.2	4SR 1/20 - S - PS		588	257	845	15.6
4SR 1/29 - S - PD		767	371	1138	17.8	4SR 1/29 - S - PS		767	272	1039	18.8
4SR 1/39 - S - PD		992	396	1388	22.8	4SR 1/39 - S - PS		992	297	1289	22.6
4SR 1/50 - S - PD		1284	437	1721	28.1	4SR 1/50 - S - PS		1284	352	1636	29.8
4SR 1.5/7 - S - PD		303	311	614	10.0	4SR 1.5/7 - S - PS		303	237	540	10.1
4SR 1.5/11 - S - PD		382	331	713	11.7	4SR 1.5/11 - S - PS		382	237	619	11.1
4SR 1.5/15 - S - PD		488	356	844	13.8	4SR 1.5/15 - S - PS		488	257	745	13.8
4SR 1.5/22 - S - PD		627	371	998	16.2	4SR 1.5/22 - S - PS		627	272	899	16.4
4SR 1.5/30 - S - PD		787	396	1183	19.3	4SR 1.5/30 - S - PS		787	297	1084	20.5
4SR 1.5/44 - S - PD		1163	437	1600	26.6	4SR 1.5/44 - S - PS		1163	352	1515	28.0
4SR 2/6 - S - PD		283	311	594	9.8	4SR 2/6 - S - PS		283	237	520	10.2
4SR 2/9 - S - PD		343	331	674	11.4	4SR 2/9 - S - PS		343	237	580	10.7
4SR 2/12 - S - PD		402	356	758	13.1	4SR 2/12 - S - PS		402	257	659	13.2
4SR 2/17 - S - PD		528	371	899	15.0	4SR 2/17 - S - PS		528	272	800	15.5
4SR 2/23 - S - PD		647	396	1043	17.7	4SR 2/23 - S - PS		647	297	944	17.8
4SR 2/33 - S - PD		873	437	1310	22.3	4SR 2/33 - S - PS		873	352	1225	24.0
4SR 2/44 - S - PD		1163	450	1613	27.8	4SR 2/44 - S - PS		1163	484	1647	31.6
4SR 2/58 - S - PD		1432	625	2057	34.4	4SR 2/58 - S - PS		1432	574	2006	41.7
4SR 4/6 - S - PD	1 1/2"	313	331	644	11.0	4SR 4/6 - S - PS	1 1/2"	313	237	550	11.2
4SR 4/8 - S - PD		363	356	719	12.4	4SR 4/8 - S - PS		363	257	620	12.6
4SR 4/12 - S - PD		462	371	833	15.5	4SR 4/12 - S - PS		462	272	734	14.2
4SR 4/15 - S - PD		563	396	959	16.3	4SR 4/15 - S - PS		563	297	860	16.2
4SR 4/22 - S - PD		737	437	1174	20.3	4SR 4/22 - S - PS		737	352	1089	20.8
4SR 4/30 - S - PD		963	450	1413	23.7	4SR 4/30 - S - PS		963	484	1447	28.4
4SR 4/40 - S - PD		1284	625	1909	35.0	4SR 4/40 - S - PS		1284	574	1858	40.4
4SR 4/54 - S - PD		1684	725	2409	47.0	4SR 4/54 - S - PS		1684	664	2348	40.0
4SR 4/72 - S - PD		2134	845	2979	54.0	4SR 4/72 - S - PS		2134	764	2898	54.4
4SR 6/4 - S - PD		2"	289	331	620	10.8		4SR 6/4 - S - PS	2"	289	237
4SR 6/6 - S - PD	352		356	708	12.0	4SR 6/6 - S - PS	352	257		609	12.4
4SR 6/9 - S - PD	446		371	817	13.9	4SR 6/9 - S - PS	446	272		718	14.0
4SR 6/13 - S - PD	598		396	994	16.3	4SR 6/13 - S - PS	598	297		895	17.3
4SR 6/17 - S - PD	723		437	1160	20.0	4SR 6/17 - S - PS	723	352		1075	20.4
4SR 6/24 - S - PD	969		450	1419	23.5	4SR 6/24 - S - PS	969	484		1453	27.3
4SR 6/32 - S - PD	1247		625	1872	32.0	4SR 6/32 - S - PS	1247	574		1821	35.2
4SR 6/43 - S - PD	1618		725	2343	45.0	4SR 6/43 - S - PS	1618	664		2282	45.0
4SR 6/58 - S - PD	2161		845	3006	55.0	4SR 6/58 - S - PS	2161	764		2925	55.0
4SR 8/4 - S - PD	289		356	645	11.6	4SR 8/4 - S - PS	289	257		546	11.1
4SR 8/7 - S - PD	382		371	753	13.4	4SR 8/7 - S - PS	382	272		654	14.3
4SR 8/9 - S - PD	446		396	842	15.1	4SR 8/9 - S - PS	446	297		743	15.0
4SR 8/13 - S - PD	598		437	1035	18.2	4SR 8/13 - S - PS	598	352		950	18.8
4SR 8/17 - S - PD	723		450	1173	21.1	4SR 8/17 - S - PS	723	484		1207	25.8
4SR 8/24 - S - PD	969		625	1594	30.0	4SR 8/24 - S - PS	969	574		1543	33.7
4SR 8/32 - S - PD	1247		725	1972	40.6	4SR 8/32 - S - PS	1247	664		1911	39.4
4SR 8/43 - S - PD	1618	845	2463	49.0	4SR 8/43 - S - PS	1618	764	2382	49.0		

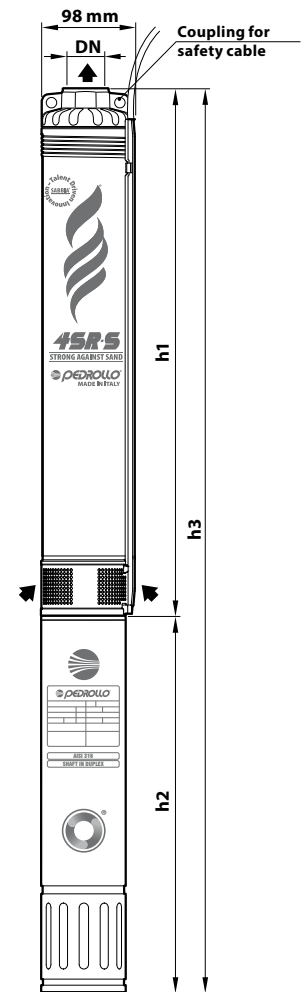

※ 4PD = rewindable in oil filled motor

※ 4PS = encapsulated water filled motor

4SR 4" submersible pumps

DIMENSIONS AND WEIGHT

TYPE	DN	DIMENSIONS mm			kg	TYPE	DN	DIMENSIONS mm			kg		
		h1	h2	h3				h1	h2	h3			
Single-phase ✖						Single-phase ✖							
4SRm 10/5 - N - PD	2"	430	357	787	12.4	4SRm 10/5 - N - PS	2"	430	272	702	13.0		
4SRm 10/7 - N - PD		532	397	929	16.7	4SRm 10/7 - N - PS		532	312	844	17.7		
4SRm 10/9 - N - PD		633	437	1070	18.9	4SRm 10/9 - N - PS		633	352	985	20.6		
4SRm 10/13 - N - PD		837	492	1329	25.6	4SRm 10/13 - N - PS		837	402	1239	24.9		
4SRm 12/5 - N - PD		488	357	845	13.0	4SRm 12/5 - N - PS		488	272	760	13.5		
4SRm 12/7 - N - PD		613	397	1010	15.5	4SRm 12/7 - N - PS		613	312	925	16.5		
4SRm 12/9 - N - PD		738	437	1175	18.5	4SRm 12/9 - N - PS		738	352	1090	20.0		
4SRm 12/13 - N - PD		989	492	1481	23.5	4SRm 12/13 - N - PS		989	402	1391	23.0		
4SRm 15/6 - N - PD		550	397	947	16.0	4SRm 15/6 - N - PS		550	312	862	16.0		
4SRm 15/8 - N - PD		676	437	1113	19.5	4SRm 15/8 - N - PS		676	352	1028	19.5		
4SRm 15/12 - N - PD		926	492	1418	22.5	4SRm 15/12 - N - PS		926	402	1328	22.5		
4SRm 18/4 - N - PD		446	396	843	14.1	4SRm 18/4 - N - PS		446	335	781	15.1		
4SRm 18/6 - N - PD		582	437	1019	16.5	4SRm 18/6 - N - PS		582	370	952	18.2		
4SRm 18/9 - N - PD		786	492	1277	21.2	4SRm 18/9 - N - PS		786	425	1211	20.5		
Three-phase ✖								Three-phase ✖					
4SR 10/5 - N - PD		2"	430	357	787	12.4		4SR 10/5 - N - PS	2"	430	257	687	11.8
4SR 10/7 - N - PD	532		372	904	14.2	4SR 10/7 - N - PS	532	272		804	13.9		
4SR 10/9 - N - PD	633		397	1030	15.9	4SR 10/9 - N - PS	633	297		930	16.9		
4SR 10/13 - N - PD	837		437	1274	19.2	4SR 10/13 - N - PS	837	352		1189	20.9		
4SR 10/18 - N - PD	1092		450	1542	23.0	4SR 10/18 - N - PS	1092	484		1576	26.8		
4SR 10/24 - N - PD	1398		625	2023	32.4	4SR 10/24 - N - PS	1398	574		1972	37.4		
4SR 10/32 - N - PD	1805		725	2530	43.4	4SR 10/32 - N - PS	1805	664		2469	43.8		
4SR 10/43 - N - PD	2366		845	3211	52.0	4SR 10/43 - N - PS	2366	764		3130	52.4		
4SR 12/5 - N - PD	488		357	845	13.0	4SR 12/5 - N - PS	488	257		745	12.0		
4SR 12/7 - N - PD	613		372	985	14.5	4SR 12/7 - N - PS	613	272		885	14.5		
4SR 12/9 - N - PD	738		397	1135	17.0	4SR 12/9 - N - PS	738	297		1035	18.0		
4SR 12/13 - N - PD	989		437	1426	20.5	4SR 12/13 - N - PS	989	352		1341	22.0		
4SR 12/18 - N - PD	1302		450	1752	25.0	4SR 12/18 - N - PS	1302	484		1786	25.6		
4SR 12/24 - N - PD	1677		625	2302	34.5	4SR 12/24 - N - PS	1677	574		2251	38.0		
4SR 12/32 - N - PD	2178		725	2903	46.1	4SR 12/32 - N - PS	2178	664		2842	46.5		
4SR 12/40 - N - PD	2679		845	3524	54.0	4SR 12/40 - N - PS	2679	764		3443	54.0		
4SR 15/6 - N - PD	550		372	922	15.0	4SR 15/6 - N - PS	550	272		822	14.0		
4SR 15/8 - N - PD	676		397	1073	17.9	4SR 15/8 - N - PS	676	297		973	17.5		
4SR 15/12 - N - PD	926		437	1363	22.4	4SR 15/12 - N - PS	926	352		1278	21.5		
4SR 15/16 - N - PD	1176		450	1626	25.4	4SR 15/16 - N - PS	1176	484		1660	27.5		
4SR 15/21 - N - PD	1489		625	2114	33.0	4SR 15/21 - N - PS	1489	574		2063	36.5		
4SR 15/29 - N - PD	1990		725	2715	48.2	4SR 15/29 - N - PS	1990	664		2654	45.0		
4SR 15/39 - N - PD	2616		845	3461	58.0	4SR 15/39 - N - PS	2616	764		3380	53.5		
4SR 18/4 - N - PD	446		371	818	13.3	4SR 18/4 - N - PS	446	290		736	13.0		
4SR 18/6 - N - PD	582		396	978	15.0	4SR 18/6 - N - PS	582	335		917	16.0		
4SR 18/9 - N - PD	786		437	1222	18.0	4SR 18/9 - N - PS	786	370		1156	19.7		
4SR 18/12 - N - PD	990		450	1440	20.9	4SR 18/12 - N - PS	990	425		1415	24.7		
4SR 18/16 - N - PD	1261		625	1886	31.4	4SR 18/16 - N - PS	1261	544		1805	34.3		
4SR 18/22 - N - PD	1668		725	2393	39.7	4SR 18/22 - N - PS	1668	654		2322	41.9		
4SR 18/30 - N - PD	2211		845	3056	49.8	4SR 18/30 - N - PS	2211	764		2975	49.9		

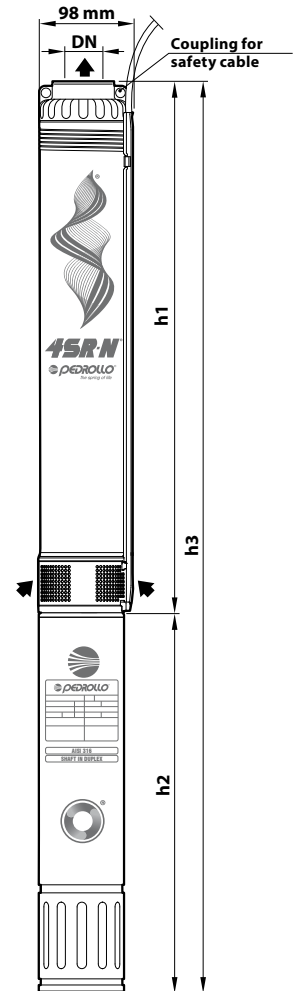

✖ 4PD = motore in bagno d'olio riavvolgibile

✖ 4PS = motore incapsulato in bagno d'acqua

EXAMPLES OF INSTALLATION

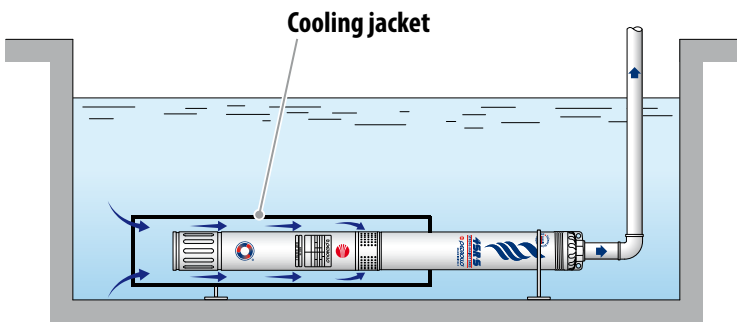

COOLING JACKET

✘ When the pump is installed in reservoirs, rivers, or lakes, it requires an external cooling jacket (flow generator) to ensure sufficient water flow across the motor surface, preventing overheating.



- ✘ The **4SR** pumps are suitable for wells with a minimum diameter of **4" (100 mm)**.
- ✘ The submersible pump must be lowered into the well through the delivery pipe to a depth that ensures it remains fully submerged, maintaining at least 50 cm or one metre from the bottom of the well, even if liquid levels decrease during operation.
- ✘ It is advisable to secure the submersible pump using a stainless-steel cable connected to appropriate attachments on the delivery port.

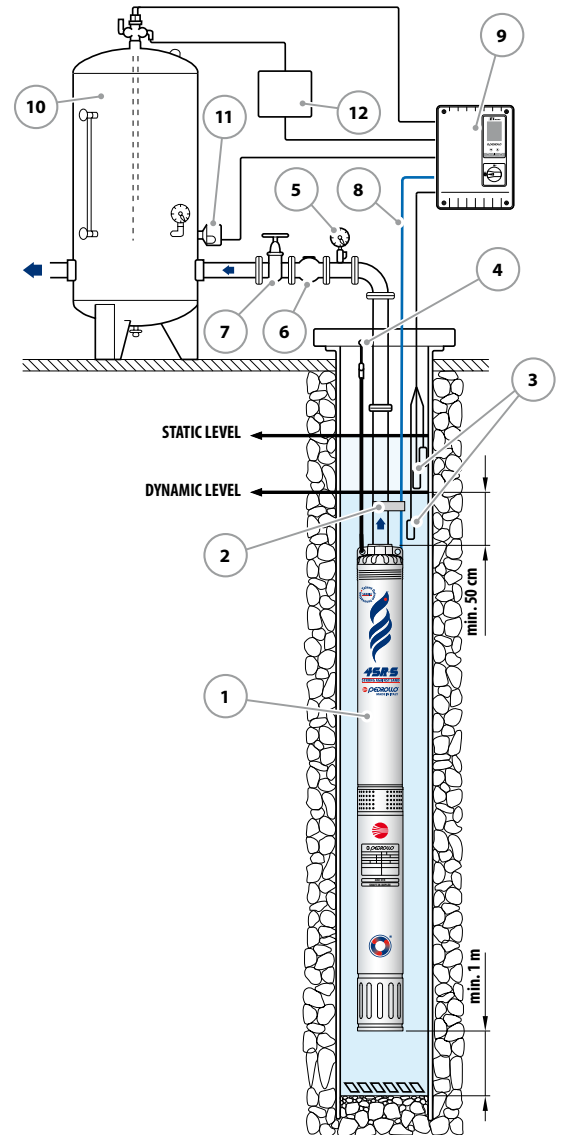

COMPONENTS

- 1) Submersible pump
- 2) Fixing Ties
- 3) Level control probes
- 4) Bracket and anchor cable
- 5) Pressure Gauge
- 6) Check valve
- 7) Flow control gate valve
- 8) Electrical power supply cable
- 9) Control panel
- 10) Autoclave tank
- 11) Pressure switch
- 12) Solenoid valve/electric compressor