



### CAMPO DE PRESTACIONES

- Caudal hasta **1800 l/min** (108 m<sup>3</sup>/h)
- Altura manométrica hasta **349 m**

### LÍMITES DE USO

- Temperatura máxima del fluido hasta **+35 °C**
- Contenido de arena máximo **100 g/m<sup>3</sup>**
- Profundidad de uso hasta **200 m** bajo el nivel del agua
- Funcionamiento:
  - en vertical
  - en horizontal con los siguientes límites:
    - 6HR200G hasta **7 etapas**
    - 6HR250G hasta **6 etapas**
    - 6HR300G hasta **6 etapas**
    - 6HR370G hasta **4 etapas**
- Arranques/hora: **20** a intervalos regulares
- Flujo de enfriamiento mínimo **10 cm/s**
- Funcionamiento continuo **S1**

### EJECUCIÓN Y NORMAS DE SEGURIDAD

#### MOTOR ELÉCTRICO

– Trifásica 380 V - 60 Hz

Cable de alimentación de **4 m**

**EN 60335-1**  
**IEC 60335-1**  
**CEI 61-150**

**EN 60034-1**  
**IEC 60034-1**  
**CEI 2-3**



### CERTIFICACIONES

Empresa con sistema de gestión certificado DNV  
ISO 9001: CALIDAD

### USOS E INSTALACIONES

Se aconsejan para bombear agua limpia con contenido de arena no superior a **100 g/m<sup>3</sup>**. Debido a su alto rendimiento y fiabilidad se indican para usos en el campo civil, agrícola e industrial, para la distribución del agua en acoplamiento con autoclaves, para riegos, para aumentos de presión y para instalaciones anti-incendio, etc.

### PATENTES - MARCAS - MODELOS

Modelo comunitario registrado n° 004675106-0001, 004675106-0002

### EJECUCIÓN BAJO PEDIDO

- Cuerpo bomba con bocas roscadas ISO 228/1
- Bombas 6HR-HYD con doble protector de cable para el acoplamiento con motores con doble tensión 400/690 V **Y/Δ** (estrella/triángulo)
- Otros voltajes

### GARANTIA

2 años según nuestras condiciones generales de venta

## CURVAS Y DATOS DE PRESTACIONES

60 Hz n = 3450 min<sup>-1</sup>

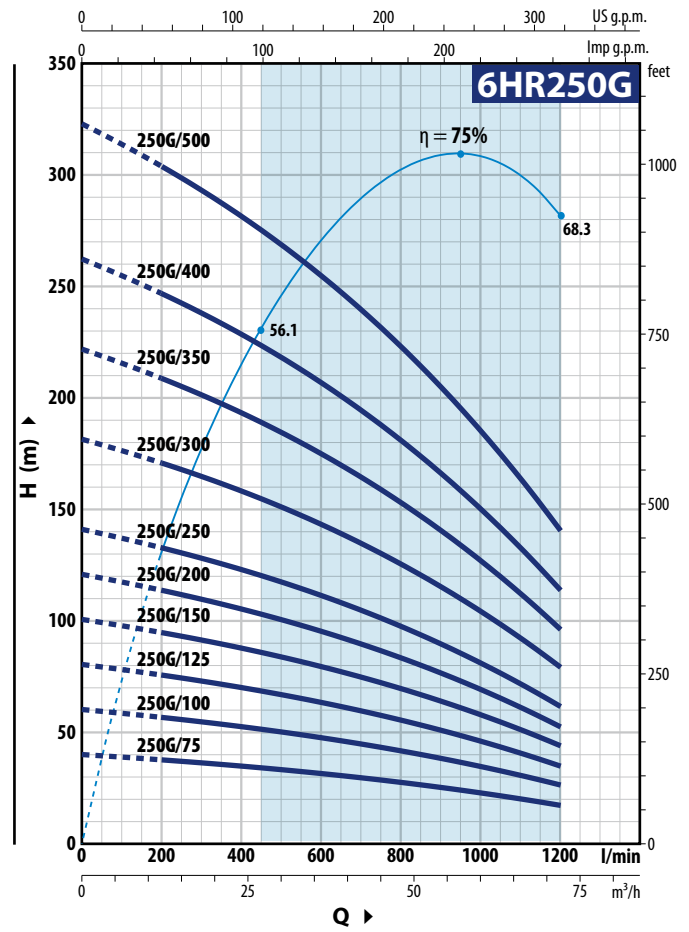
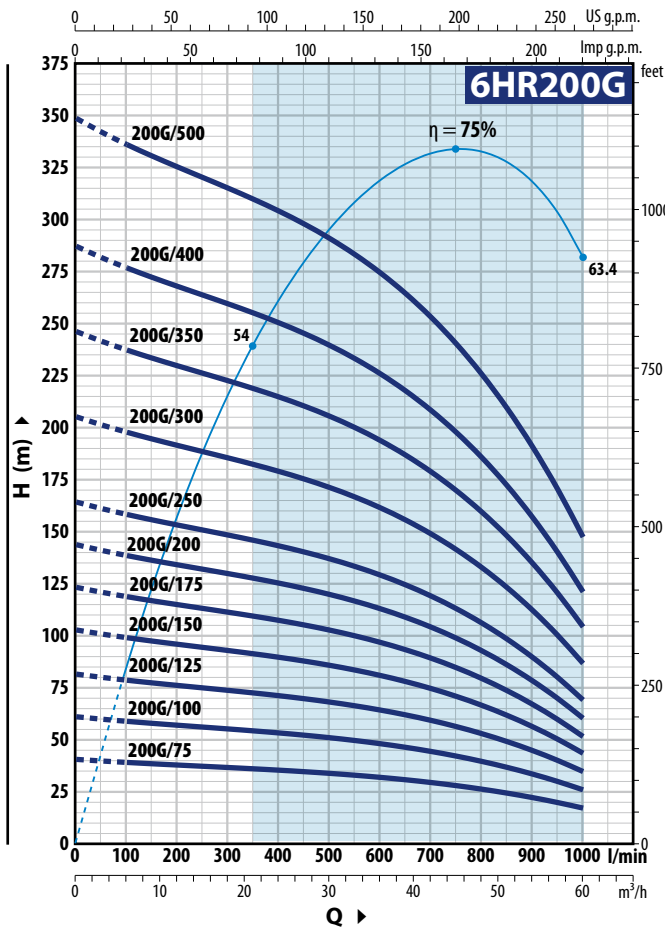

### 6HR200G

MODELO	N. ETAPAS	POTENCIA (P <sub>2</sub> )		Q	m <sup>3</sup> /h														
		kW	HP		0	6	12	18	24	30	36	42	48	54	60				
Trifásica					0	100	200	300	400	500	600	700	800	900	1000				
6HR200G/75	2	5.5	7.5	H metros	41	39.5	38.5	37	36	34	32.5	30	26.6	22.5	17.5				
6HR200G/100	3	7.5	10		61.5	59.5	57.5	55.5	53.5	51.5	48.5	44.5	40	33.5	26				
6HR200G/125	4	9.2	12.5		82	79	77	74	72	68.5	64.5	59.5	53	45	34.5				
6HR200G/150	5	11	15		103	99	96	93	89	86	81	74	66.5	56	43.5				
6HR200G/175	6	13	17.5 <sup>(1)</sup>		123	119	115	111	107	103	97	89	80	67.5	52				
6HR200G/200	7	15	20		144	138	134	130	125	120	113	104	93	79	60.5				
6HR200G/250	8	18.5	25		164	158	153	148	143	137	129	119	106	90	69.5				
6HR200G/300	10	22	30		205	198	191	185	179	171	161	149	133	112	87				
6HR200G/350	12	26	35 <sup>(2)</sup>		246	237	230	222	215	205	194	179	159	135	104				
6HR200G/400	14	30	40		287	277	268	259	250	240	226	208	186	157	121				
6HR200G/500	17	37	50	349	336	325	315	304	291	274	253	226	191	147					

### 6HR250G

MODELO	N. ETAPAS	POTENCIA (P <sub>2</sub> )		Q	m <sup>3</sup> /h													
		kW	HP		0	12	18	24	30	36	42	48	54	60	66	72		
Trifásica					0	200	300	400	500	600	700	800	900	1000	1100	1200		
6HR250G/75	2	5.5	7.5	H metros	40.5	38	36.5	35	33.5	32	30	28	25.6	23.2	20.5	17.5		
6HR250G/100	3	7.5	10		60.5	57	55	53	50.5	48	45	42	38.5	35	30.5	26.5		
6HR250G/125	4	9.2	12.5		81	76	73	70	67.5	64	60	56	51.5	46.5	41	35		
6HR250G/150	5	11	15		101	95	92	88	84	80	75	70	64	58	51	44		
6HR250G/200	6	15	20		121	114	110	106	101	96	90	84	77	69.5	61.5	52.5		
6HR250G/250	7	18.5	25		142	133	128	123	118	112	105	98	90	81	72	61.5		
6HR250G/300	9	22	30		182	171	165	159	151	144	135	126	115	104	92	79		
6HR250G/350	11	26	35 <sup>(2)</sup>		222	209	202	194	185	175	165	154	141	127	113	97		
6HR250G/400	13	30	40		263	247	239	229	219	207	195	181	167	151	133	114		
6HR250G/500	16	37	50		323	304	294	282	269	255	240	223	205	185	164	141		

Q = Caudal H = Altura manométrica total

(1) Electrobomba equipada con motor de 20 HP

(2) Electrobomba equipada con motor de 40 HP

Tolerancia de las curvas de prestación según EN ISO 9906 Grado 3B.

### CURVAS Y DATOS DE PRESTACIONES

60 Hz n = 3450 min<sup>-1</sup>

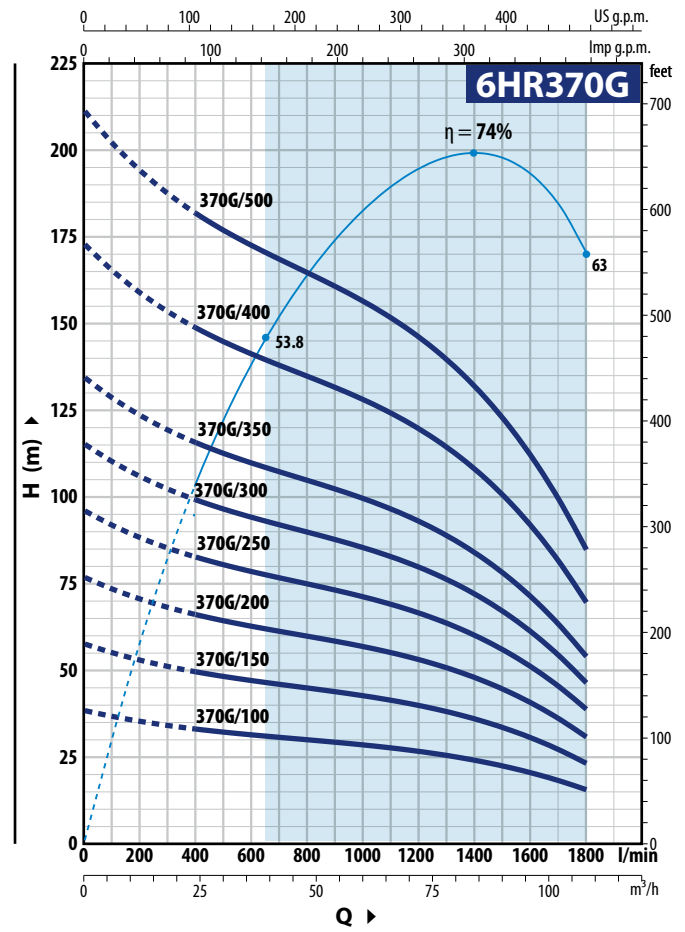
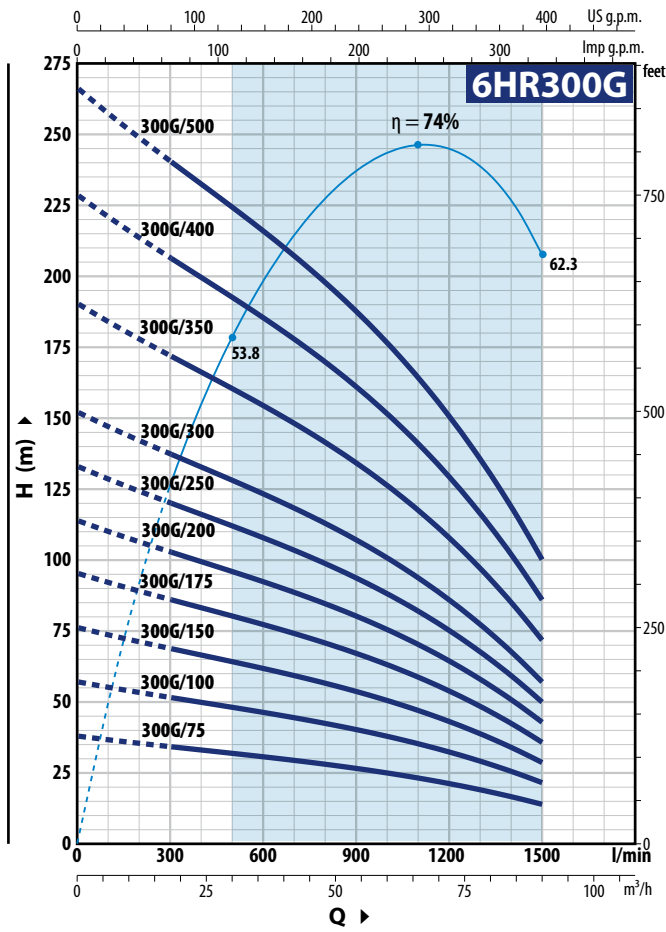

### 6HR300

MODELO	N. ETAPAS	POTENCIA (P <sub>2</sub> )		Q	m <sup>3</sup> /h														
		kW	HP		0	18	24	30	36	42	48	54	60	75	90				
Trifásica					0	300	400	500	600	700	800	900	1000	1250	1500				
6HR300G/75	2	5.5	7.5	H metros	38	34.5	33	32	31	29.5	28.5	26.8	25.2	20.5	14.5				
6HR300G/100	3	7.5	10		57	51.5	50	48	46.5	44.5	42.5	40	38	30.5	21.5				
6HR300G/150	4	11	15		76	69	66.5	64	62	59	56.5	53.5	50.5	41	28.5				
6HR300G/175	5	13	17.5 <sup>(1)</sup>		95	86	83	80	77	74	71	67	63	51	36				
6HR300G/200	6	15	20		114	103	100	96	93	89	85	80	76	61.5	43				
6HR300G/250	7	18.5	25		133	120	116	112	108	104	99	94	88	72	50				
6HR300G/300	8	22	30		152	138	133	128	124	118	113	107	101	82	57.5				
6HR300G/350	10	26	35 <sup>(2)</sup>		190	172	166	160	154	148	141	134	126	102	72				
6HR300G/400	12	30	40		228	206	199	192	185	178	170	161	151	123	86				
6HR300G/500	14	37	50		267	241	233	225	216	207	198	188	177	144	100				

### 6HR370

MODELO	N. ETAPAS	POTENCIA (P <sub>2</sub> )		Q	m <sup>3</sup> /h									
		kW	HP		0	24	36	48	60	72	84	96	108	
Trifásica					0	400	600	800	1000	1200	1400	1600	1800	
6HR370G/100	2	7.5	10	H metros	38.5	33	31.5	30	28.5	26.5	23.9	20.3	15.5	
6HR370G/150	3	11	15		57.5	49.5	47	45	42.5	40	36	30.5	23	
6HR370G/200	4	15	20		77	66	62.5	60	57	53	48	40.5	31	
6HR370G/250	5	18.5	25		96	83	78	75	71	66.5	60	51	38.5	
6HR370G/300	6	22	30		115	99	94	90	85	80	72	61	46	
6HR370G/350	7	26	35 <sup>(2)</sup>		134	116	110	105	99	93	84	71	54	
6HR370G/400	9	30	40		173	149	141	135	128	119	108	92	69.5	
6HR370G/500	11	37	50		211	182	172	164	156	146	132	112	85	

Q = Caudal H = Altura manométrica total  
 (1) Electrobomba equipada con motor de 20 HP  
 (2) Electrobomba equipada con motor de 40 HP

Tolerancia de las curvas de prestación según EN ISO 9906 Grado 3B.

**POS. COMPONENTE**

**CARACTERÍSTICAS CONSTRUCTIVAS**

<b>1 CUERPO DE IMPULSION</b>	Acero inoxidable micro fundido AISI 304 con boca de impulsión roscada NPT ANSI B 1.20.1
<b>2 VÁLVULA ANTIRETORNO</b>	Acero inoxidable AISI 304
<b>3 SOPORTE</b>	Acero inoxidable micro fundido AISI 304 dimensiones según norma NEMA
<b>4 RODETES</b>	Acero inoxidable micro fundido AISI 304
<b>5 DIFUSORES</b>	Acero inoxidable micro fundido AISI 304
<b>6 EJE BOMBA</b>	Acero inoxidable AISI 304
<b>7 RODAMIENTOS BOMBA</b>	Elastómero especial
<b>8 ANILLOS DE DESGASTE</b>	Elastómero especial
<b>9 CASQUILLO</b>	Acero inoxidable AISI 304
<b>10 FILTRO</b>	Acero inoxidable AISI 304
<b>11 PROTECTOR CABLE</b>	Acero inoxidable AISI 304
<b>12 MOTOR 6"</b>	<b>6PD</b> = motor en baño de aceite "PEDROLLO"

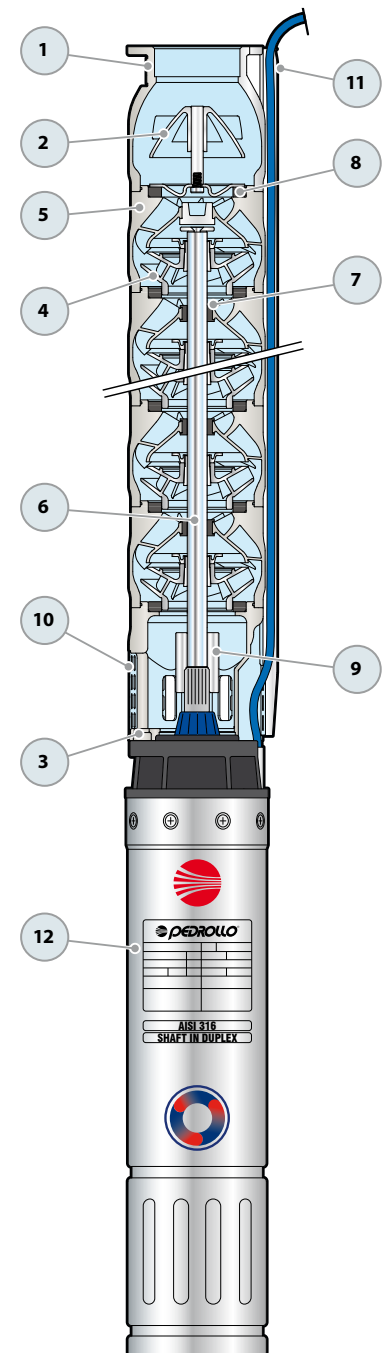

### DIMENSIONES Y PESOS (Bombas combinadas con motores sumergibles 6PD)

MODELO Trifásica	BOCA DN	Ø	DIMENSIONES mm			kg 3~
			h1	h2	h3	
6HR200G/75 - PD	3" NPT	150	480	625	1105	53.8
6HR200G/100 - PD			581	660	1241	65.2
6HR200G/125 - PD			682	700	1382	71.2
6HR200G/150 - PD			783	765	1548	78.8
6HR200G/175 - PD			884	820	1704	94.0
6HR200G/200 - PD			985	820	1805	97.7
6HR200G/250 - PD			1086	883	1969	111.3
6HR200G/300 - PD			1288	953	2241	124.9
6HR200G/350 - PD			1490	1098	2588	149.1
6HR200G/400 - PD			1692	1098	2790	158.9
6HR200G/500 - PD			1995	1233	3228	167.9
6HR250G/75 - PD			480	625	1105	53.7
6HR250G/100 - PD			581	660	1241	60.2
6HR250G/125 - PD			682	700	1382	66.2
6HR250G/150 - PD			783	765	1548	73.7
6HR250G/200 - PD			884	820	1704	88.3
6HR250G/250 - PD			985	883	1868	101.8
6HR250G/300 - PD			1187	953	2140	114.9
6HR250G/350 - PD			1389	1098	2487	138.0
6HR250G/400 - PD			1591	1098	2689	146.1
6HR250G/500 - PD			1894	1233	3127	163.8
6HR300G/75 - PD			492	625	1117	53.8
6HR300G/100 - PD			599	660	1259	60.4
6HR300G/150 - PD			706	765	1471	70.5
6HR300G/175 - PD			813	820	1633	82.1
6HR300G/200 - PD			920	820	1740	88.7
6HR300G/250 - PD			1027	883	1910	102.3
6HR300G/300 - PD			1134	953	2087	112.0
6HR300G/350 - PD			1348	1098	2446	135.2
6HR300G/400 - PD			1562	1098	2660	143.5
6HR300G/500 - PD			1776	1233	3009	157.7
6HR370G/100 - PD			492	660	1152	56.7
6HR370G/150 - PD			599	765	1364	66.7
6HR370G/200 - PD	706	820	1526	78.3		
6HR370G/250 - PD	813	883	1696	94.9		
6HR370G/300 - PD	920	953	1873	103.4		
6HR370G/350 - PD	1027	1098	2125	124.0		
6HR370G/400 - PD	1241	1098	2339	131.2		
6HR370G/500 - PD	1455	1233	2688	148.3		

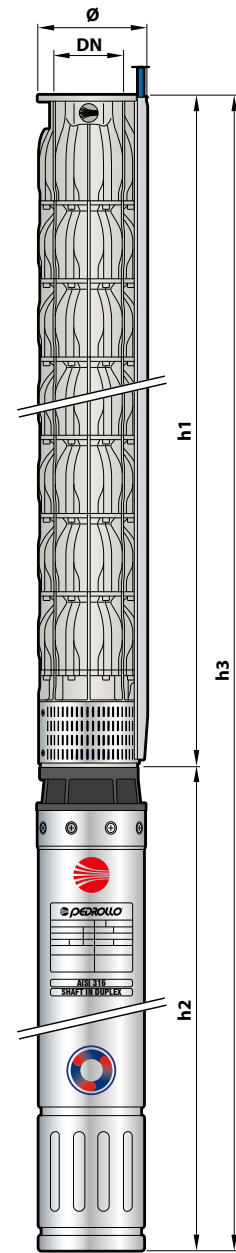

### KIT CONTROLBRIDA (SE PUEDE PEDIR A PARTE)

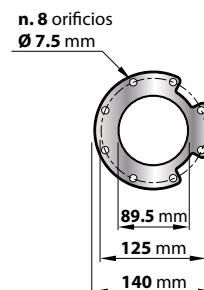

Kit preparado con:  
controlbrida, junta, tornillo e tuerca

## DIMENSIONES Y PESOS (SOLO HIDRÁULICA)

MODELO Bomba	BOCA DN	DIMENSIONES mm		kg 3~
		Ø	h1	
6HR200G/75 - HYD	3" NPT	150	480	18.2
6HR200G/100 - HYD			581	21.8
6HR200G/125 - HYD			682	25.4
6HR200G/150 - HYD			783	29.0
6HR200G/175 - HYD			884	33.2
6HR200G/200 - HYD			985	36.9
6HR200G/250 - HYD			1086	40.5
6HR200G/300 - HYD			1288	48.1
6HR200G/350 - HYD			1490	55.3
6HR200G/400 - HYD			1692	65.1
6HR200G/500 - HYD			1995	75.9
6HR250G/75 - HYD			480	18.1
6HR250G/100 - HYD			581	21.6
6HR250G/125 - HYD			682	25.2
6HR250G/150 - HYD			783	28.7
6HR250G/200 - HYD			884	32.9
6HR250G/250 - HYD			985	36.4
6HR250G/300 - HYD			1187	43.5
6HR250G/350 - HYD			1389	51.0
6HR250G/400 - HYD			1591	58.1
6HR250G/500 - HYD			1894	71.8
6HR300G/75 - HYD			492	18.2
6HR300G/100 - HYD			599	21.8
6HR300G/150 - HYD			706	25.5
6HR300G/175 - HYD			813	29.1
6HR300G/200 - HYD			920	33.3
6HR300G/250 - HYD			1027	36.9
6HR300G/300 - HYD			1134	40.6
6HR300G/350 - HYD			1348	48.2
6HR300G/400 - HYD			1562	55.5
6HR300G/500 - HYD	1776	65.7		
6HR370G/100 - HYD	492	18.1		
6HR370G/150 - HYD	599	21.7		
6HR370G/200 - HYD	706	25.3		
6HR370G/250 - HYD	813	28.9		
6HR370G/300 - HYD	920	33.0		
6HR370G/350 - HYD	1027	36.6		
6HR370G/400 - HYD	1241	43.8		
6HR370G/500 - HYD	1455	51.3		

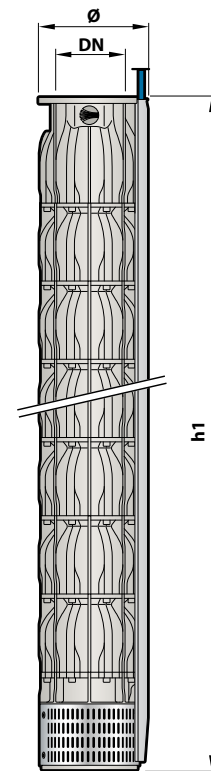

### KIT CONTROLBRIDA (SE PUEDE PEDIR A PARTE)

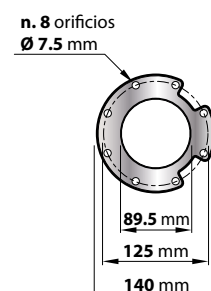

Kit preparado con:  
controlbrida, junta, tornillo e tuerca